

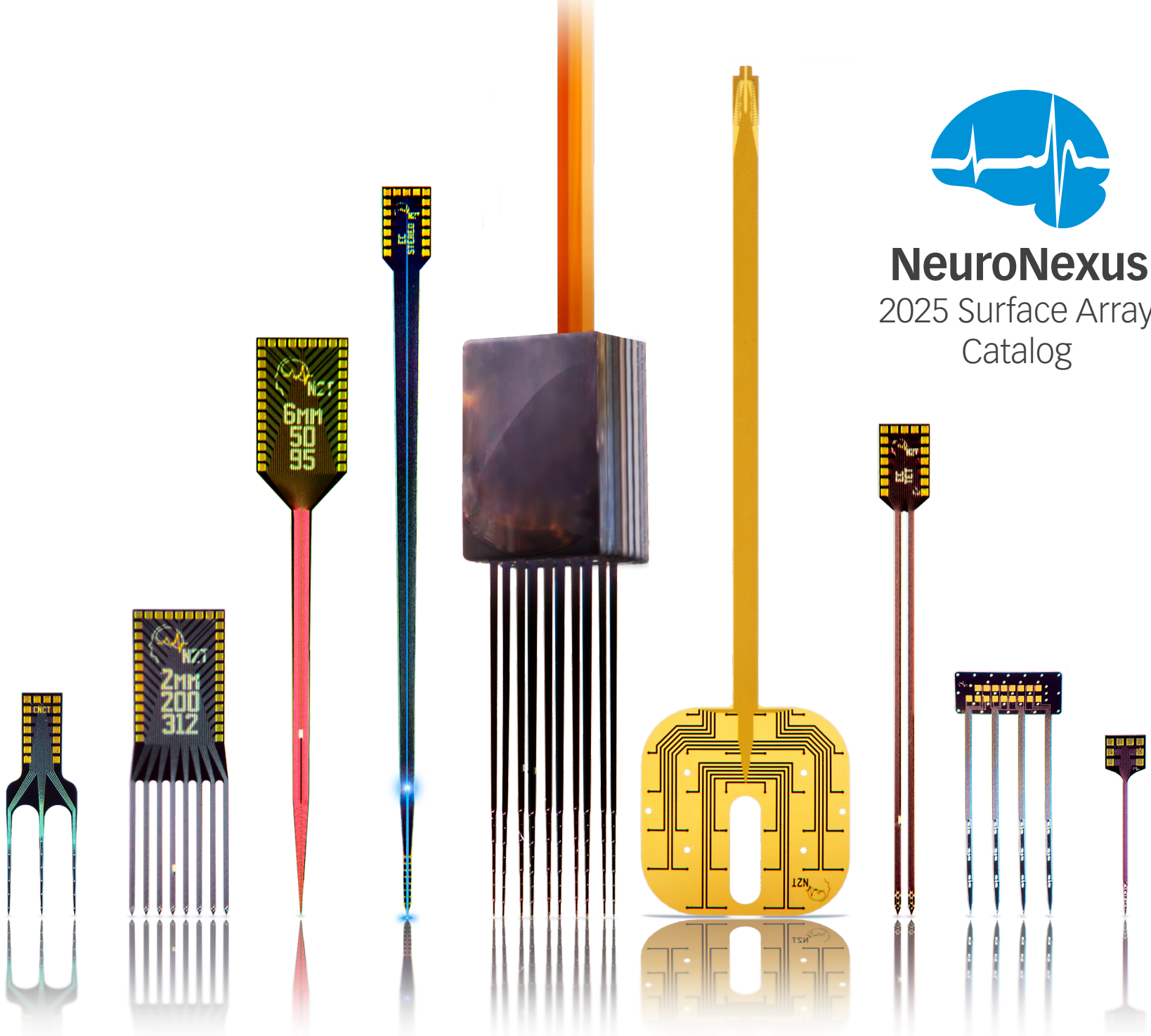

NeuroNexus

2025 Surface Array Catalog



Greetings and welcome to NeuroNexus!

We appreciate your interest in our work. As we celebrate our 20th anniversary this year, we take pride in our journey from a pioneering neurotechnology spin-out of the University of Michigan to becoming leaders in electrophysiology solutions and tools. It all started with the first commercial silicon probes, which literally created the probe market. Today, we offer a comprehensive range of high-quality silicon and polymer probes and grids, powerful instrumentation, and our innovative, highly performant Radiens software platform.

This catalog is not just a display of our products. **It is a celebration of two decades of innovation and dedication to the neuroscience community.** We recognize the complexities and challenges of brain research and are eager to enable your experiments with our advanced tools.

Please take your time to explore our offerings and do not hesitate to get in touch with us directly to discuss how we can support your research needs and ideas. Let's commemorate this milestone by continuing to explore the exciting possibilities ahead. Here's to another 20 years of pioneering and partnership!

Happy browsing!

A handwritten signature in black ink, consisting of a stylized 'D' followed by a 'K'.

Daryl Kipke, PhD
Founder and President

Contents

EEG

EEG-mouse-16-10
EEG-mouse-30-A-7
EEG-mouse-30-A-8
EEG-mouse-30-A-10
EEG-mouse-32-B-10-reticular
EEG-rat-16-10-functional
EEG-rat-32-A-10-functional
EEG-rat-32-B-10-triangular
EEG-6-4000-50-500

ECoG

E4-3000-40-500
E16-1200-1500-10-300
E16-300-5-25
E16-500-5-50
E16-500-5-200
E29-80s-25-15
E32-150-70-40
E32-250-25-30-PML
E32-300-20-50
E32-600-10-100
E32-750-10-200
E32-1000-30-200
E32-1000-20-50/100
E32-1000-30-50
E32-2000-30-100
E32-3000-20-300
E32-3000-6000-30-500
E64-400-60-40
E64-400-500-50-50

002

003
004
005
006
007
008
009
010
011

012

013
014
015
016
017
018
019
020
021
022
023
024
025
026
027
028
029
030
031

E64-500-20-60 032
E64-500-25-100 033
E64-500-80-60 034
E64-1000-50-200 035
E64-2500-50-200 036
E120-2000-100-1000 037
E128-150-186-20-60 038
E128-200-8-40 039
E128-1000-1000-60-200 040
E128-1000-80-100 041
E252-300-30-150 042
E256-200-30-80 043
EM32-2000-55-200 044
EM32-400-600-58-200 045

Cardiac Surface Grids

CS2x2x4-accord-4000-150-575 047
CS8x8-seg-2000-150-575 048
CS8x8-seg-4000-150-575 048
CS8x8-mesoA-4000-150-575 049
CS8x16-mesoA-2000-150-575 050

Peripheral Nerve Cuffs

C3 052
C24 053
C12-3000 054

Drug Delivery

E16-10mm-25-177 056
E16-10mm-50-177 057
E16-20mm-100-177 058

EEG

BACK TO
INDEX

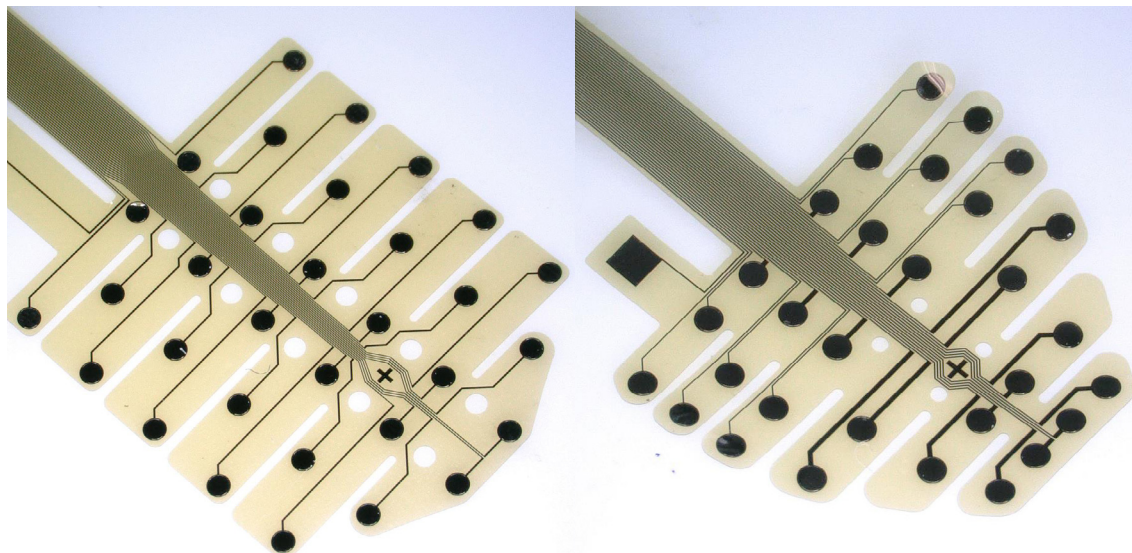

NeuroNexus **EEG probes** are ultra-flexible surface grids optimized for electroencephalography.

Flexible and Durable – Fabricated with our polymer MEMS technology, our EEG probes easily conform to the skull. Use a drop of water to adhere the probe to the skull.

Stable – High quality EEG recordings have been obtained over months.

Optimized array designs – Select from a variety of EEG array designs featuring different recording site placements, for different applications or animal models.

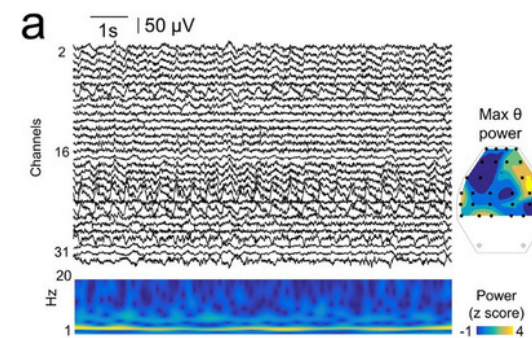

ABOVE: EEG grids allow assessment natural brain rhythms such as exploratory and REM theta (4-12 Hz) during periods free of epileptiform activities. Image courtesy of Dr. Liset de la Prida, Instituto Cajal - CSIC. <https://hippo-circuitlab.com/2017/03/eeg-grids/>

SPECIFICATIONS

Substrate Material	Polyimide
Electrode Site Material	Platinum
Array Thickness	15 µm
Cable Length	7, 8, and 10 mm
Channel Count	16, 30, and 32 Custom options available.
Available Packages	H16, HC16, HZ16, X3-H16H32, HC32, HZ32 X3-H32

EEG-mouse-16-10

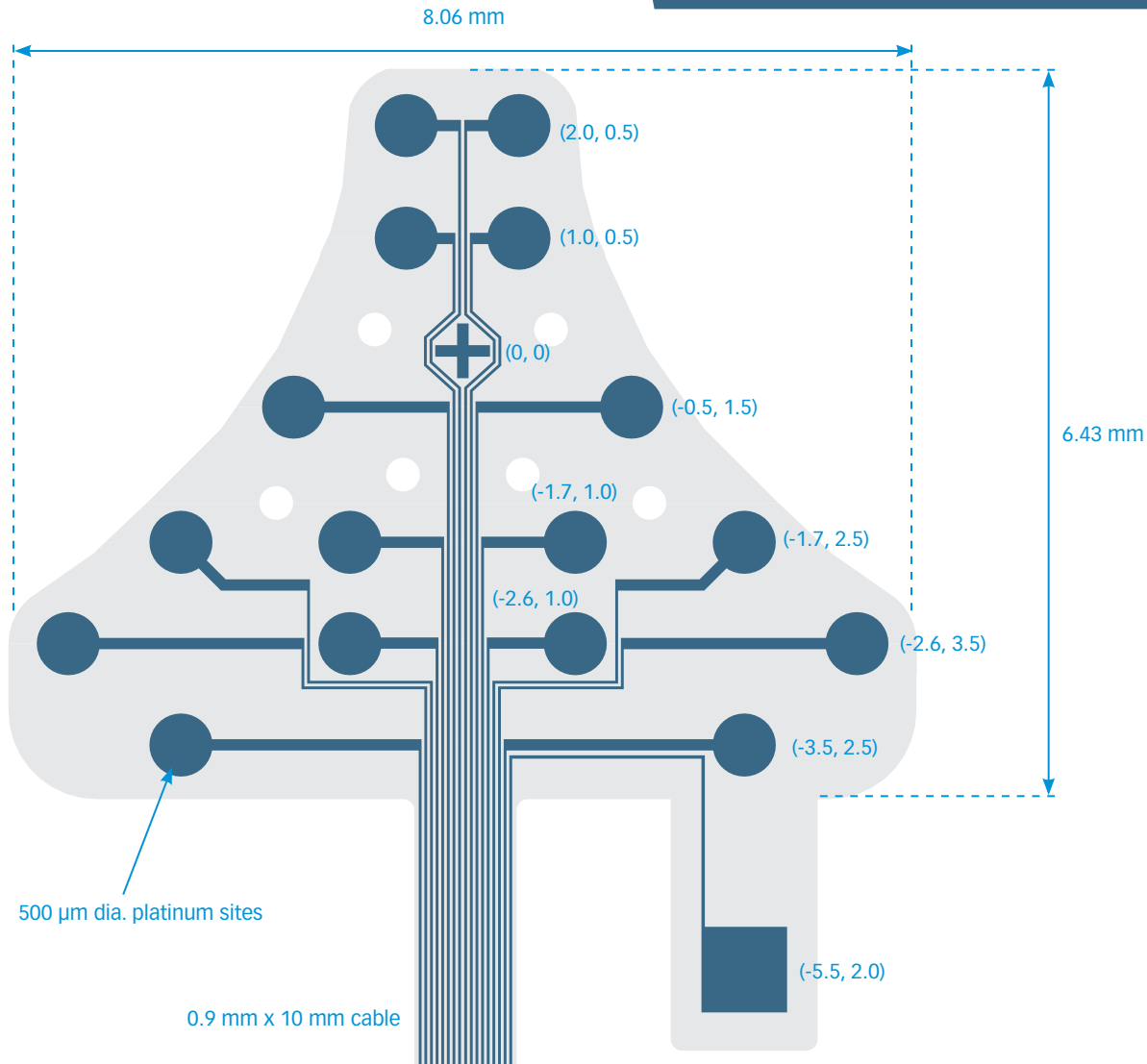

Available packages

CHRONIC

- H16
- HC16
- HZ16
- X3-H16

Thickness

15 μm

EEG-mouse-30-A-7

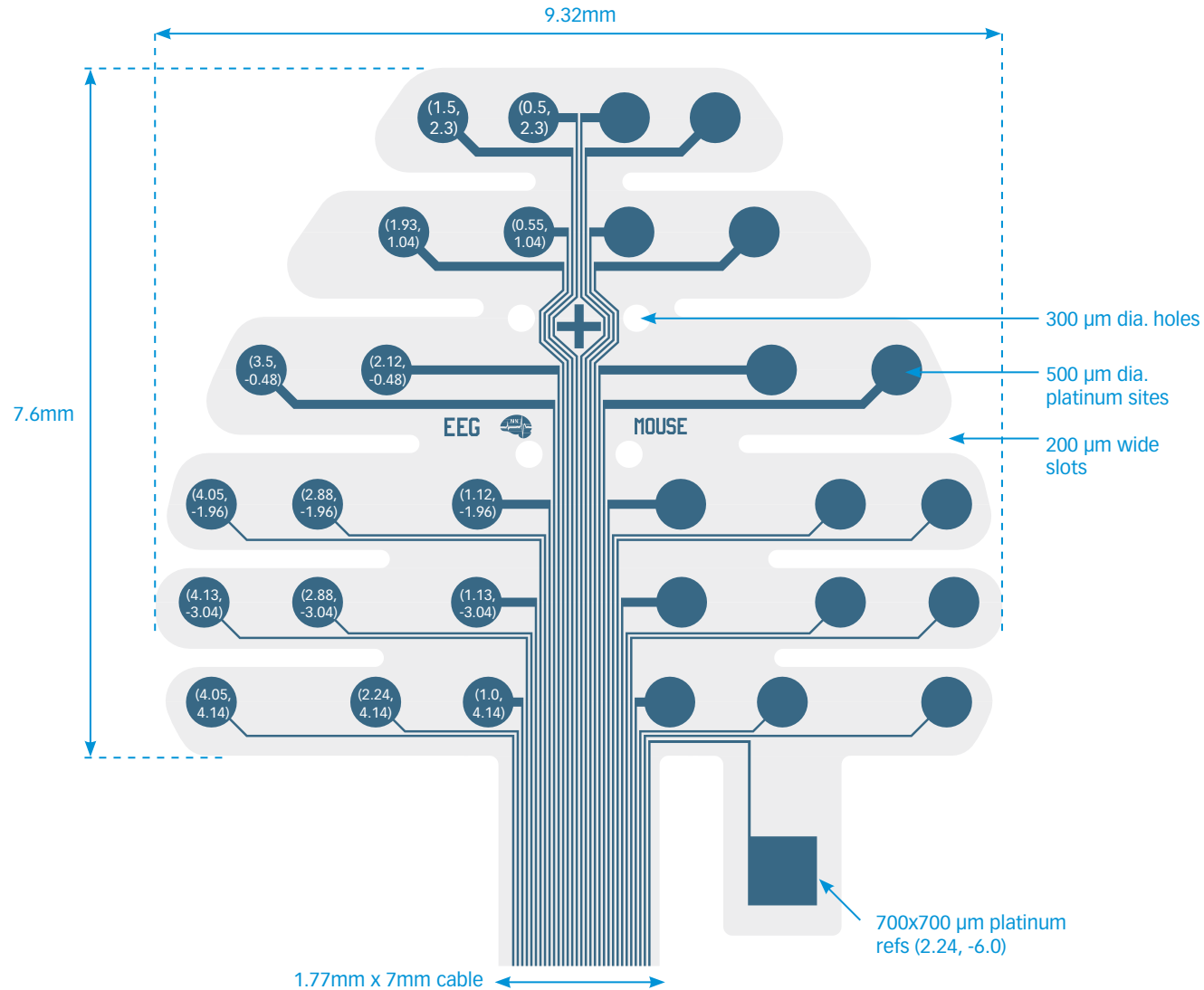

Available packages

CHRONIC

- H32
- HC32
- HZ32
- X3-H32

Thickness

15 μm

EEG-mouse-30-A-8

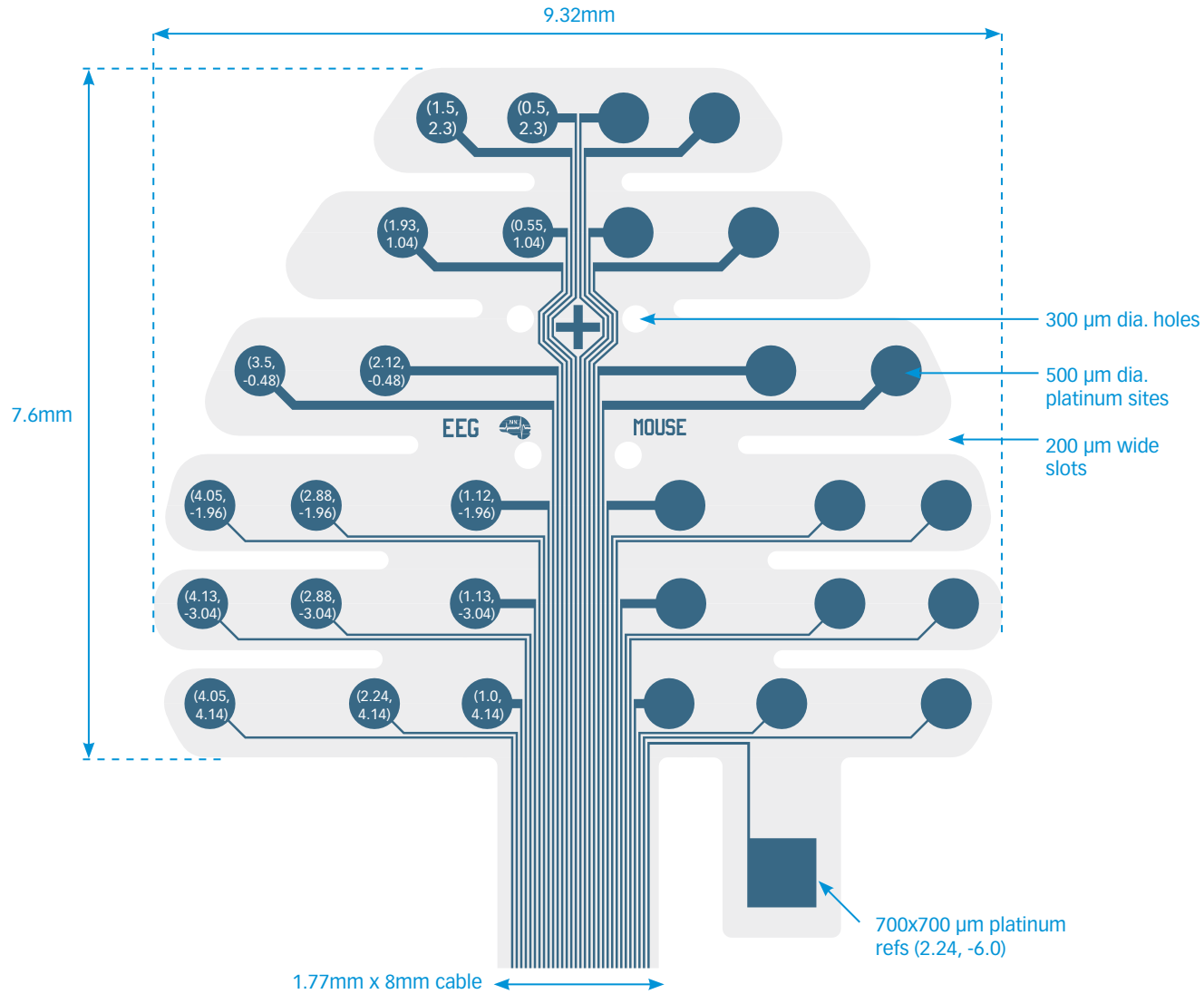

Available packages

CHRONIC

- H32
- HC32
- HZ32
- X3-H32

Thickness

15 µm

EEG-mouse-30-A-10

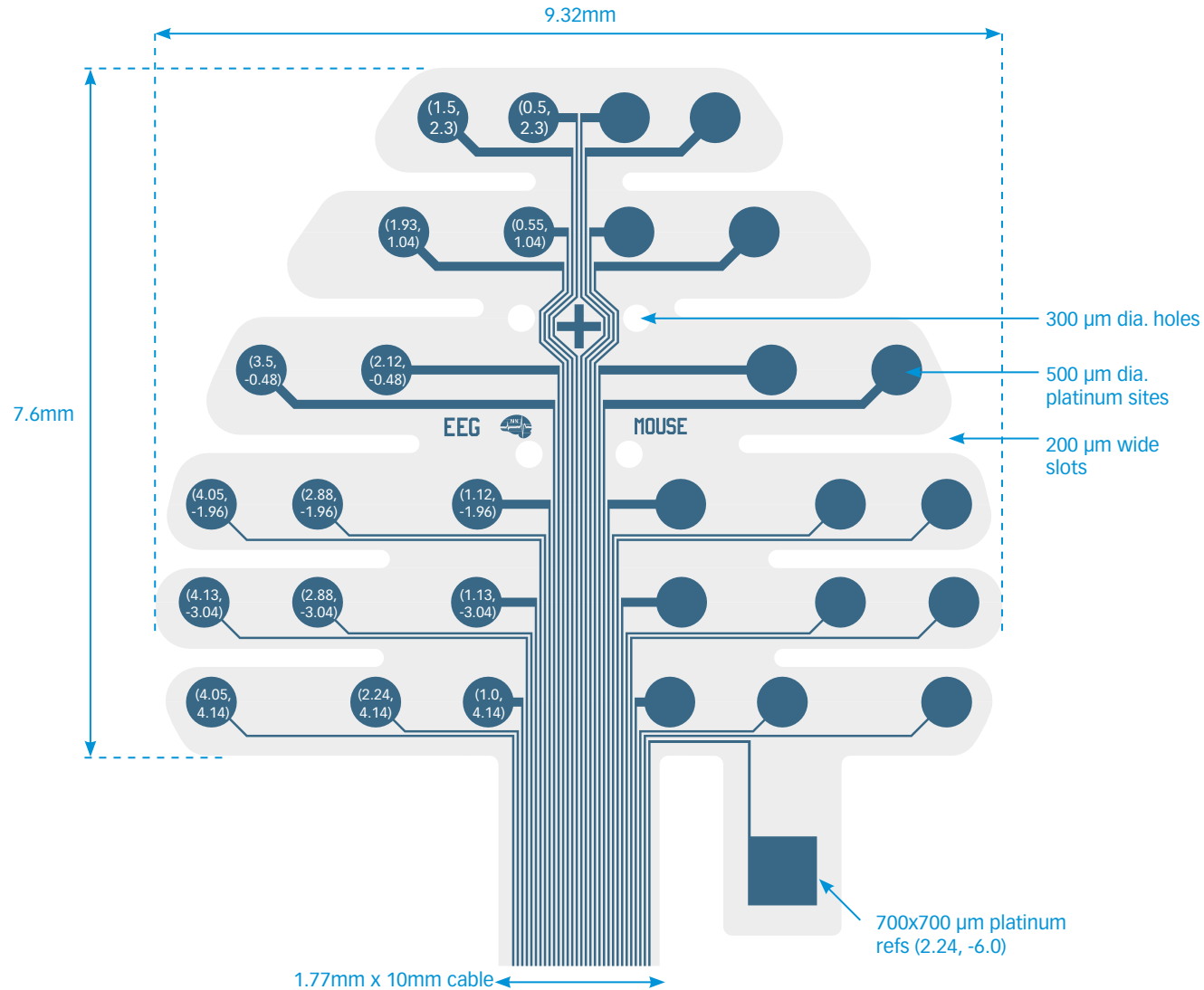

Available packages

CHRONIC

- H32
- HC32
- HZ32
- X3-H32

Thickness

15 μ m

EEG-mouse-32-B-10-reticular

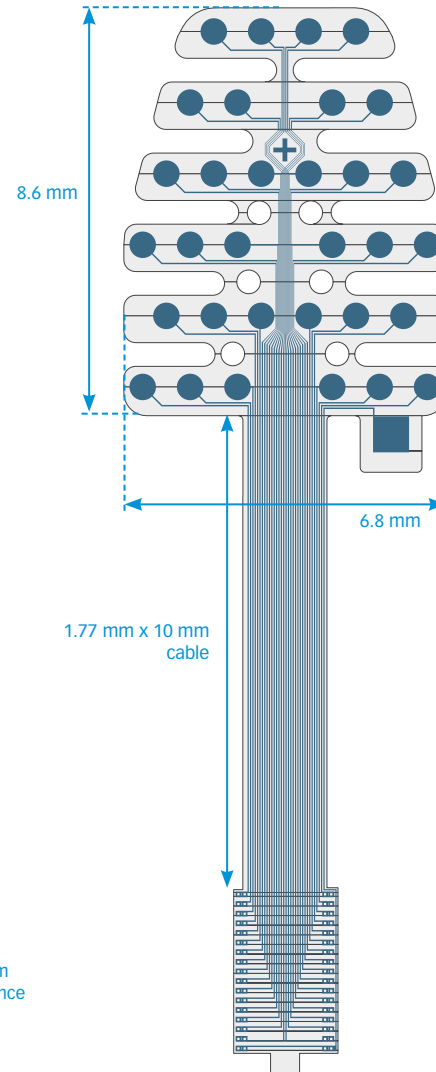
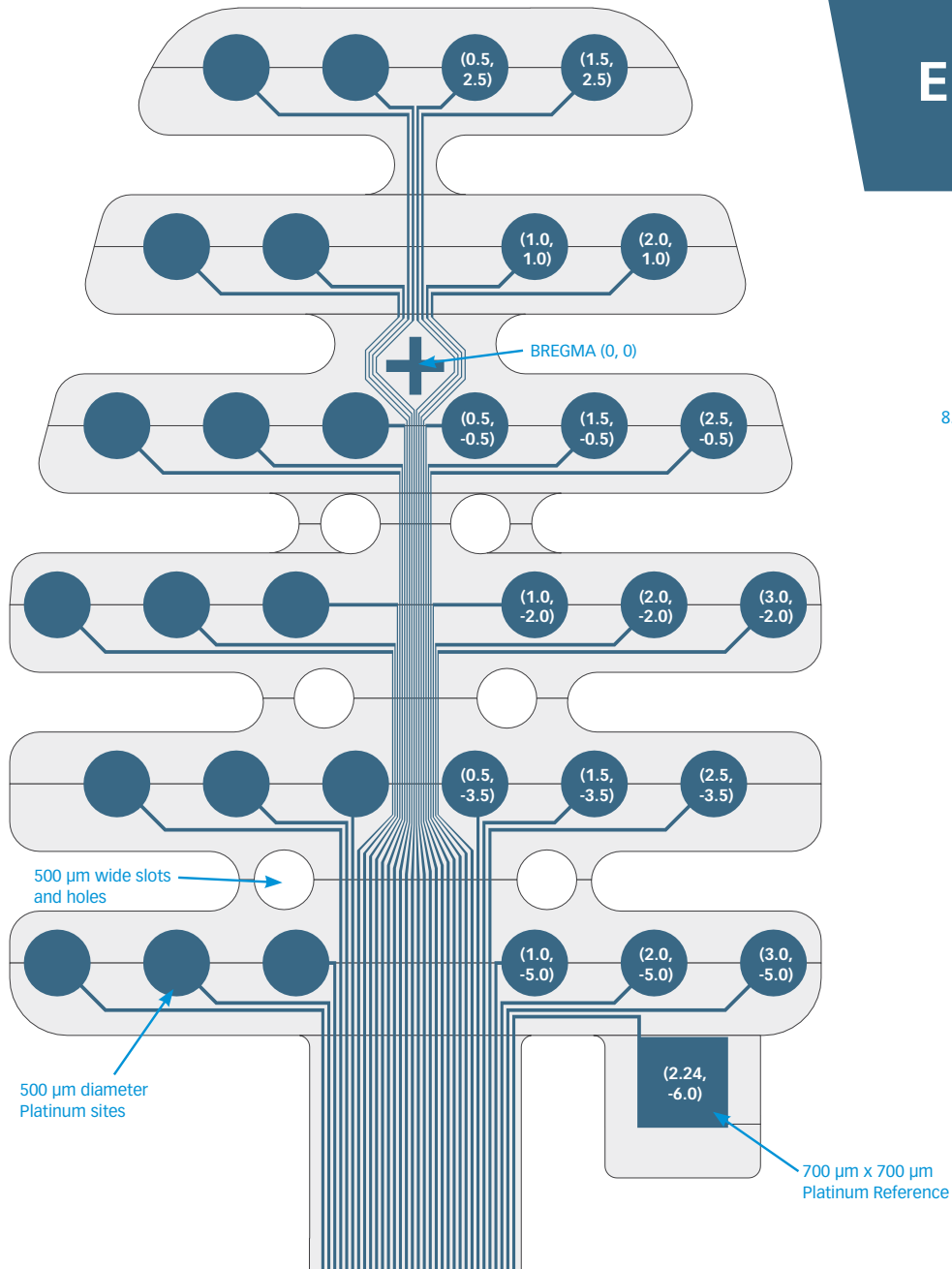

Available packages

CHRONIC

- H32
- HC32
- HZ32
- X3-H32

Thickness

15 μm

EEG-rat-16-10-functional

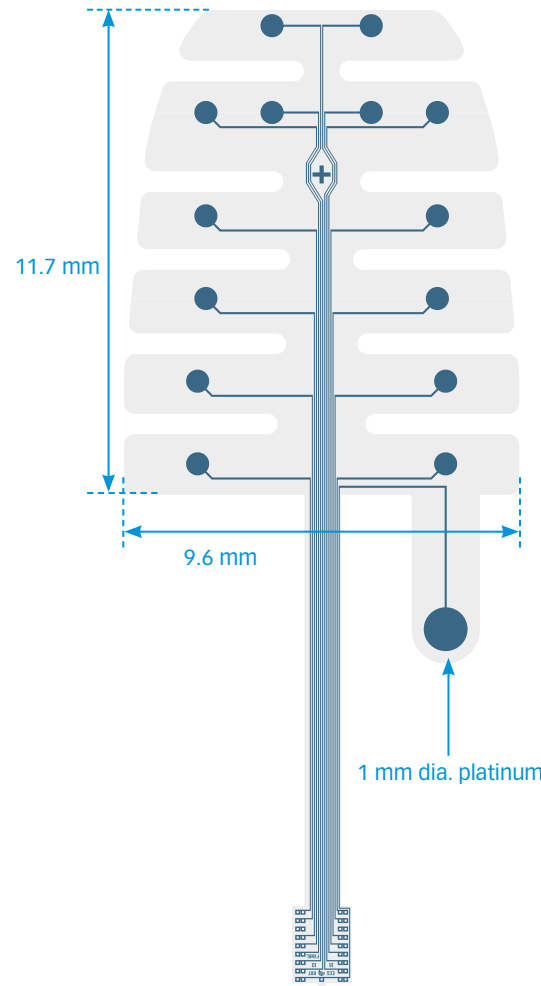
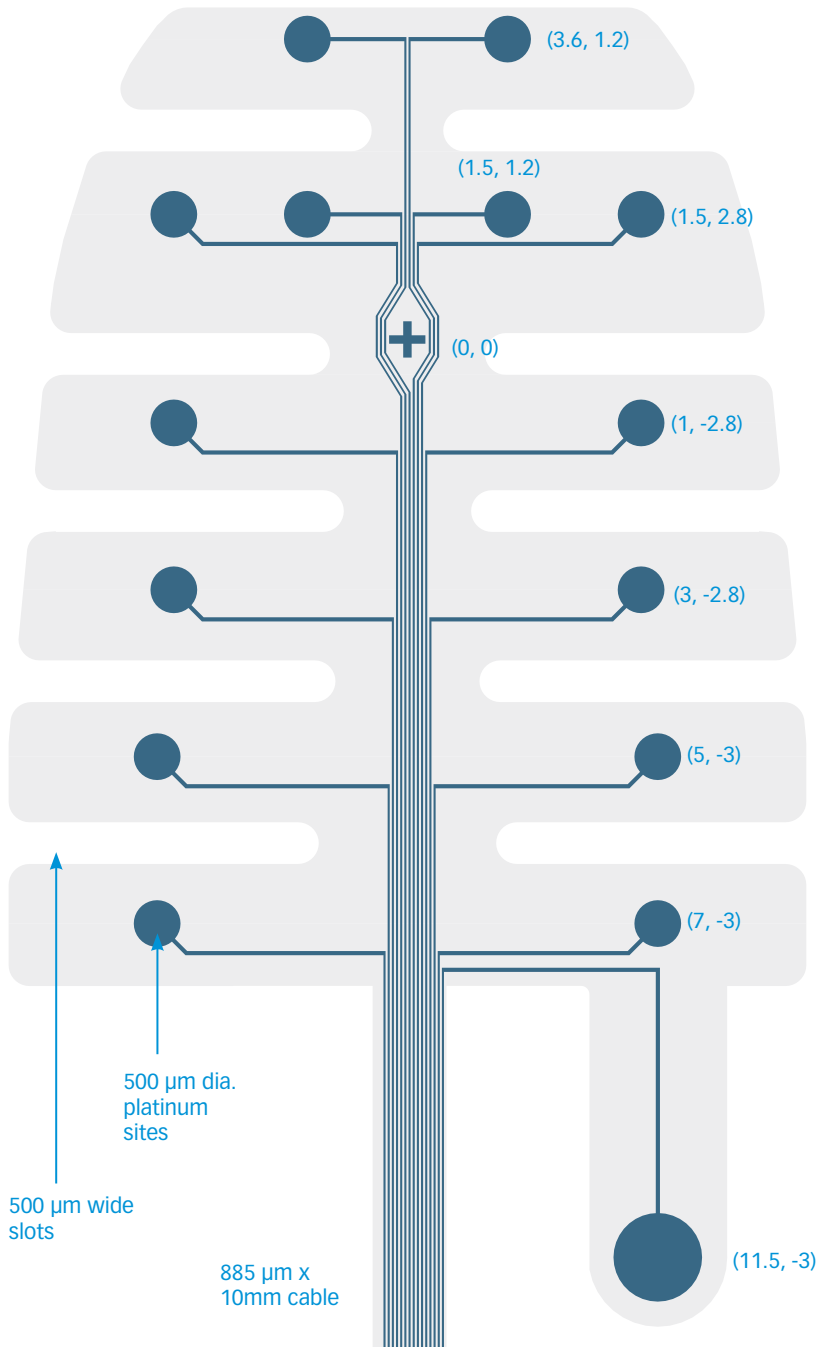

Available packages

CHRONIC

- H16
- HC16
- HZ16
- X3-H16

Thickness

15 μm

EEG-rat-32-A-10-functional

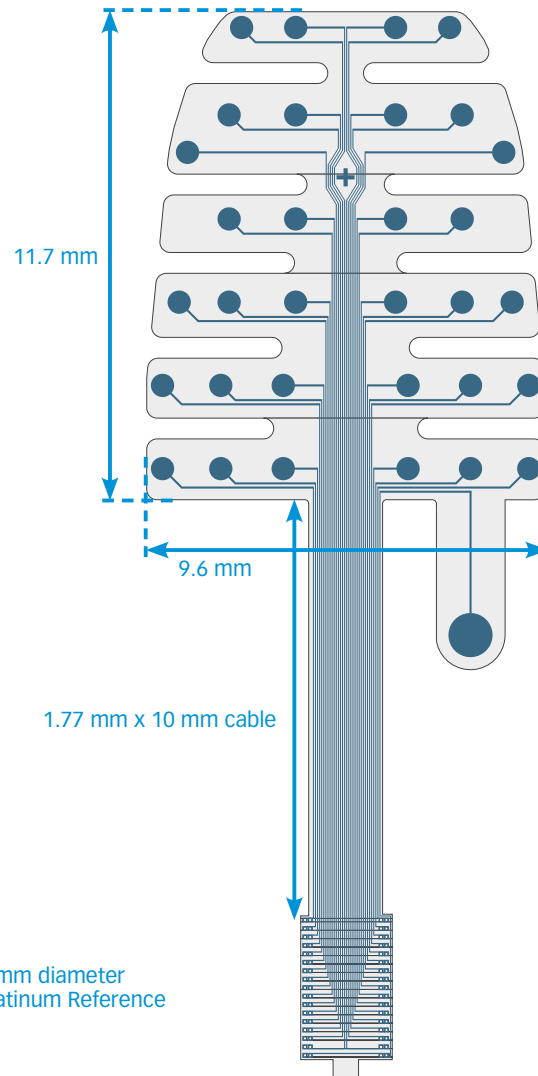
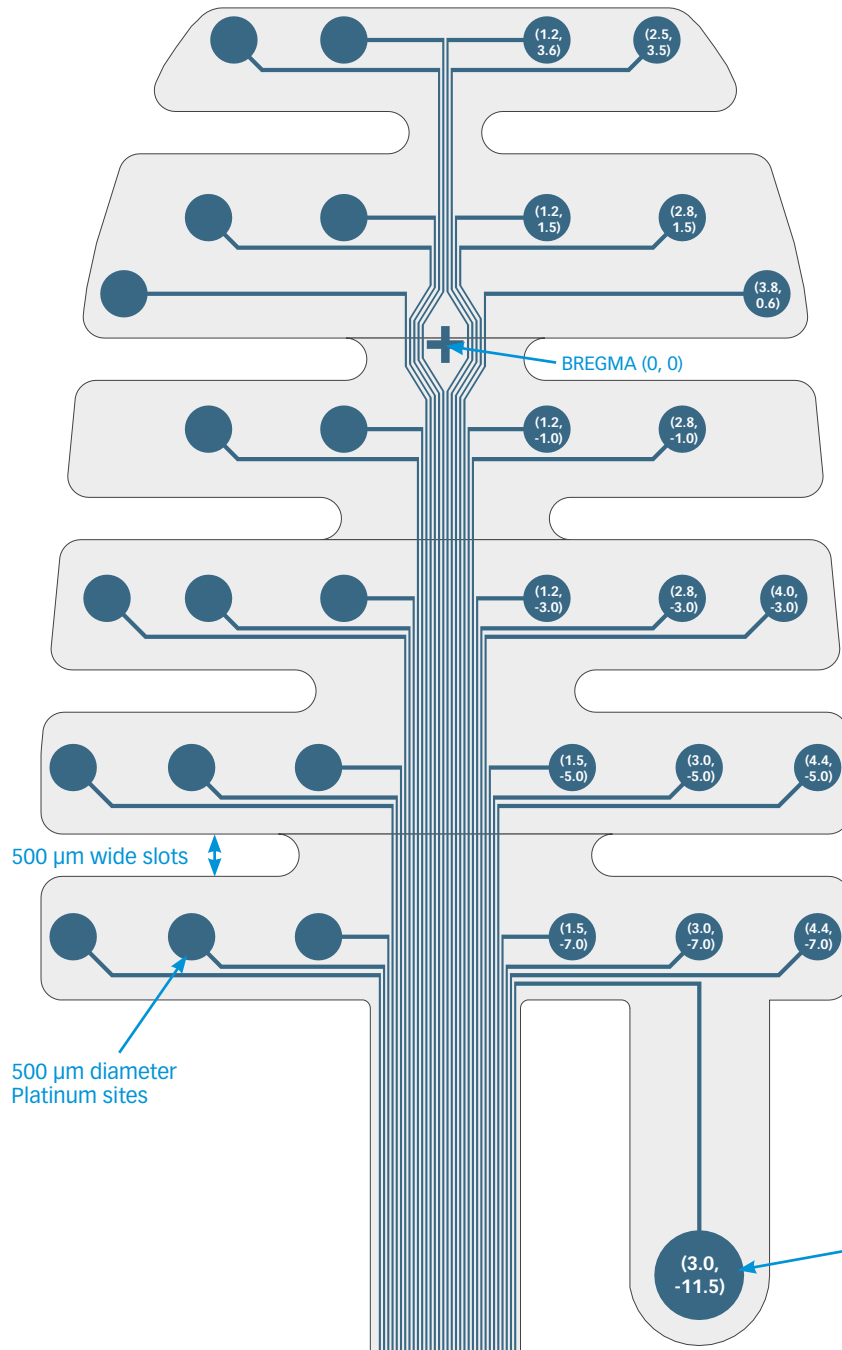

Available packages

CHRONIC

- H32
- HC32
- HZ32
- X3-H32

Thickness

15 μm

EEG-rat-32-B-10-triangular

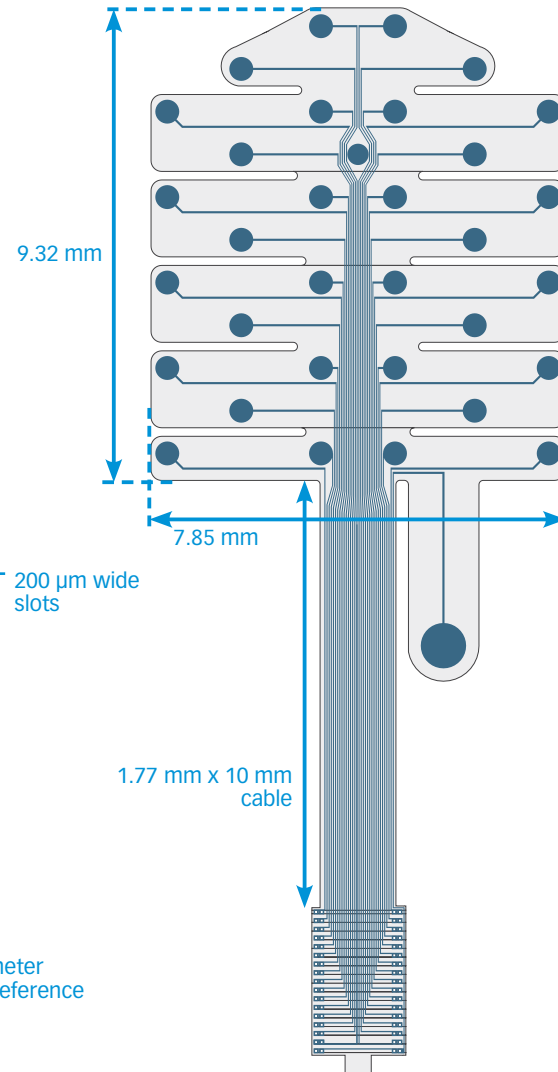
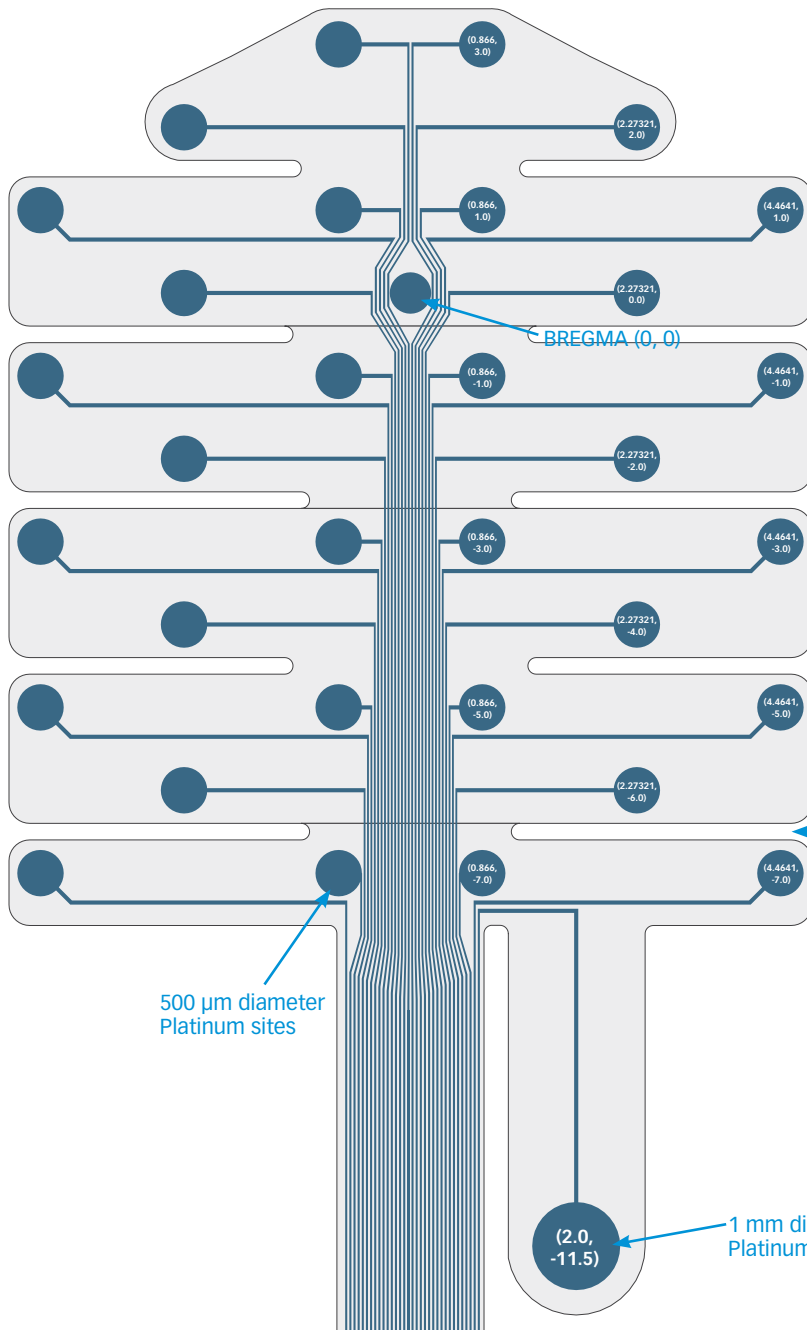

Available packages

CHRONIC

- H32
- HC32
- HZ32
- X3-H32

Thickness

15 μm

EEG-6-4000-50-500

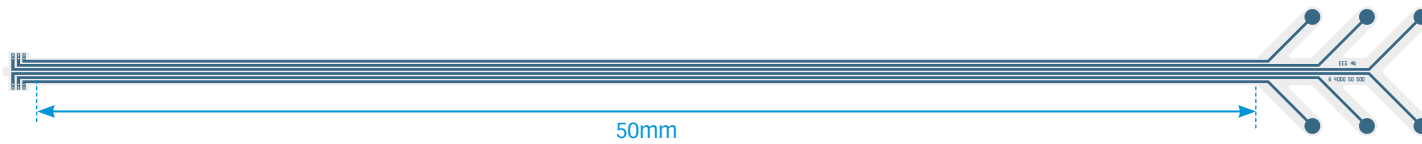

Available packages

CHRONIC

- H16
- HC16
- HZ16
- X3-H16

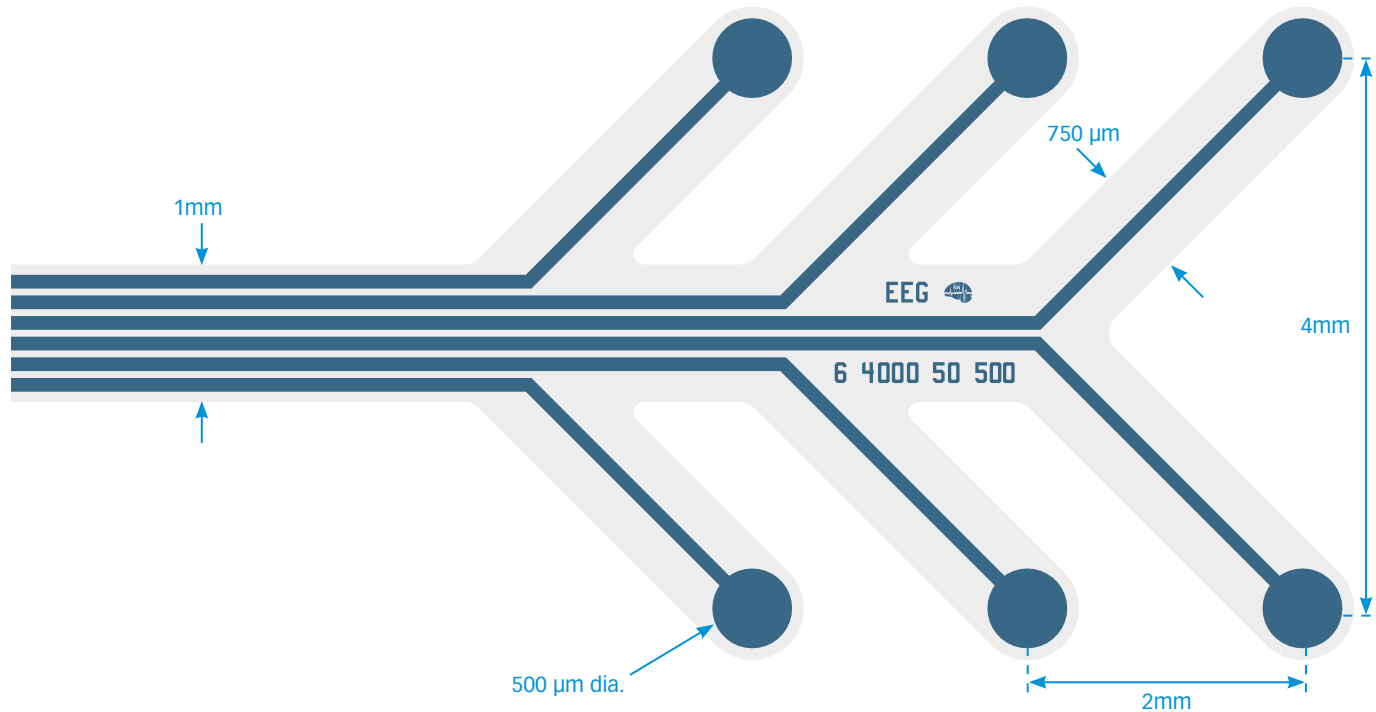

Thickness

15 μ m

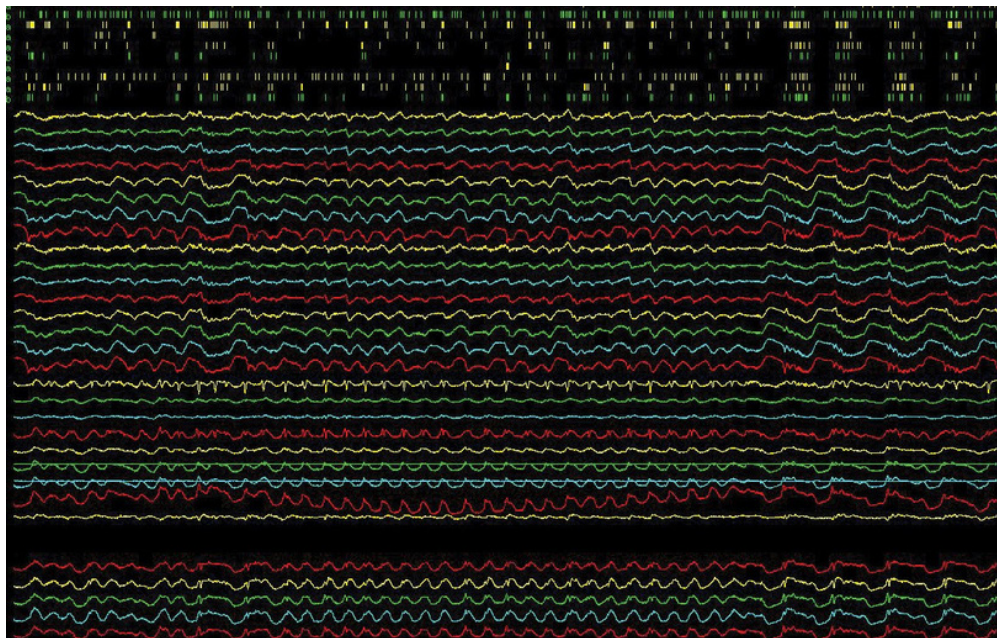

NeuroNexus **ECoG probes** are ultra-flexible surface grids with high recording resolution, designed to conform closely to the brain surface for electrocorticography.

Flexible and Durable – Fabricated with our polymer MEMS technology, our ECoG probes conform to the brain surface.

Optimized array designs – Select from a variety of ECoG array designs featuring different site spacings, for different applications or animal models.

Versatile – Combine an ECoG probe with a NeuroNexus penetrating array to establish concurrent surface and intracortical interfaces.

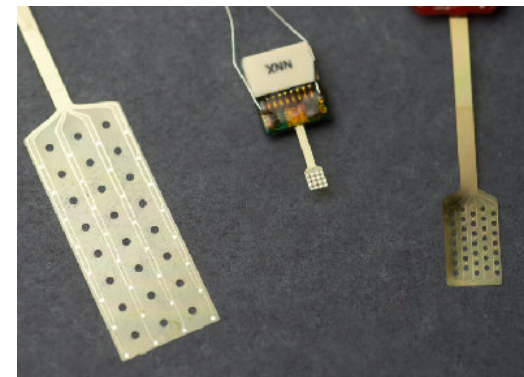

ABOVE: ECoG probes are available in different sizes and site configurations for different applications.

SPECIFICATIONS

Substrate Material	Polyimide
Electrode Site Material	Platinum
Array Thickness	15 μ m
Cable Length	5 - 100 mm (varies by design)
Channel Count	16, 32, 64, 128, 256 (varies by design)
Available Packages	H16, HC16, HZ16, X3-H16, H32, HC32, HZ32, X3-H32, H64, H64LP, HC64, HZ64, X3-H64, H128, H128LP, IH128, AVH128, AVIH128, H256, IH256, AVH256, AVIH256

E4-3000-40-500

Available packages

CHRONIC

- H16
- HC16
- HZ16
- X3-H16

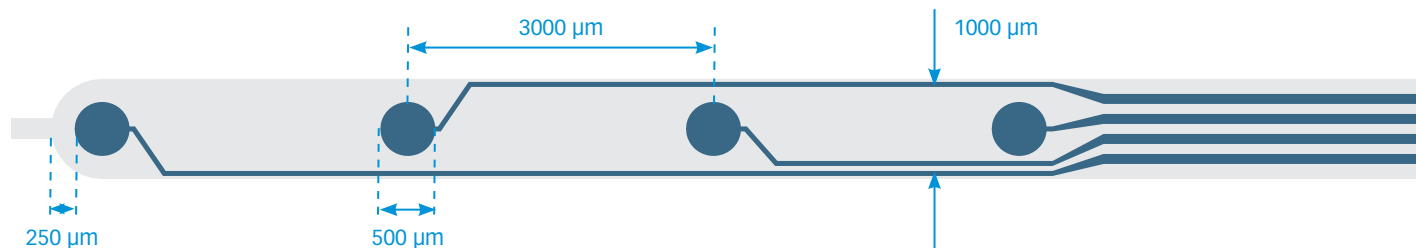
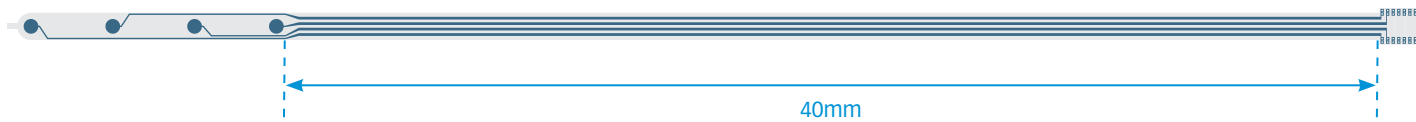

Thickness

15 μm

E16-1200-1500-10-300

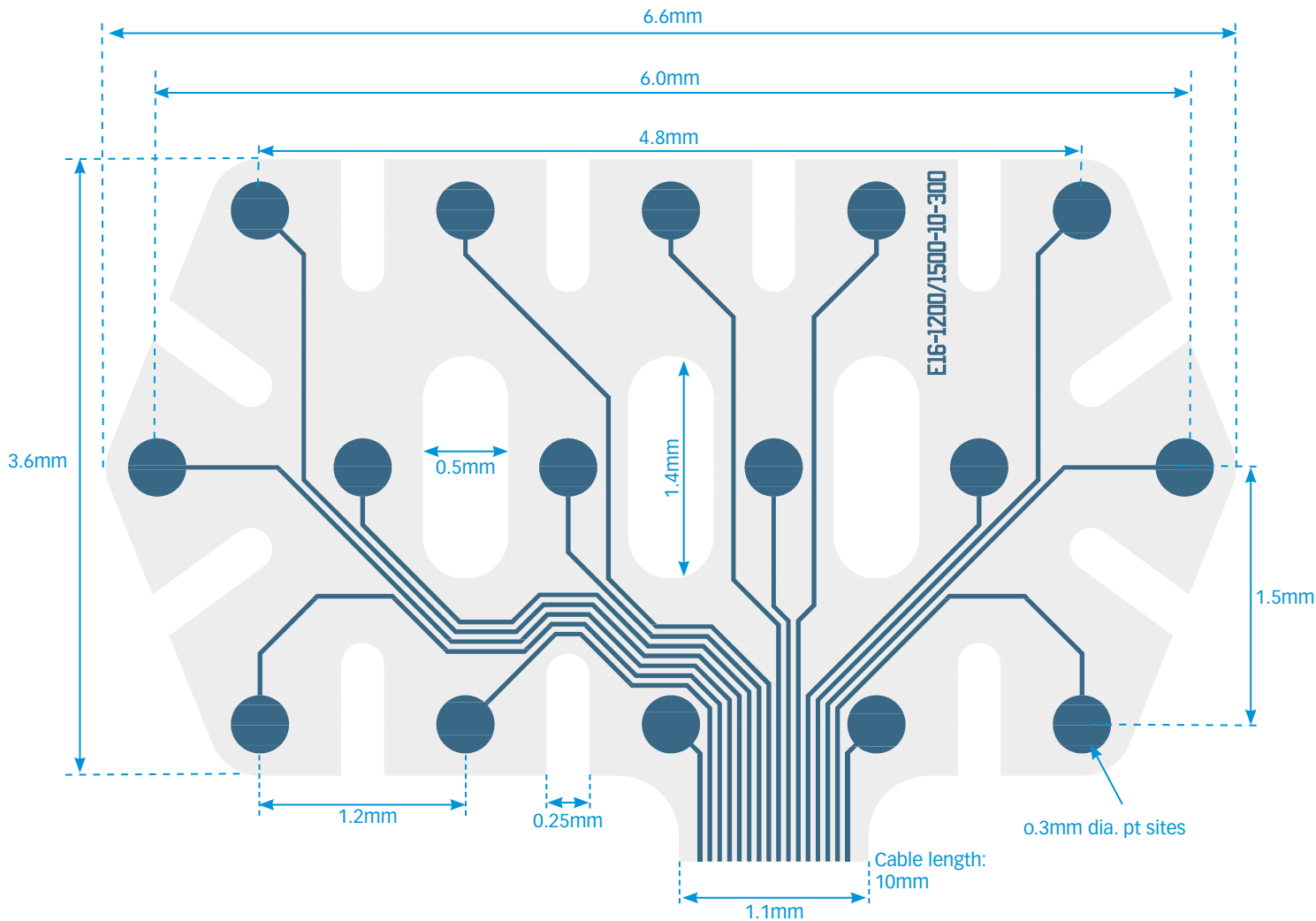

Available packages

CHRONIC

- H16
- HC16
- HZ16
- X3-H16

Thickness

15 μ m

E16-300-5-25

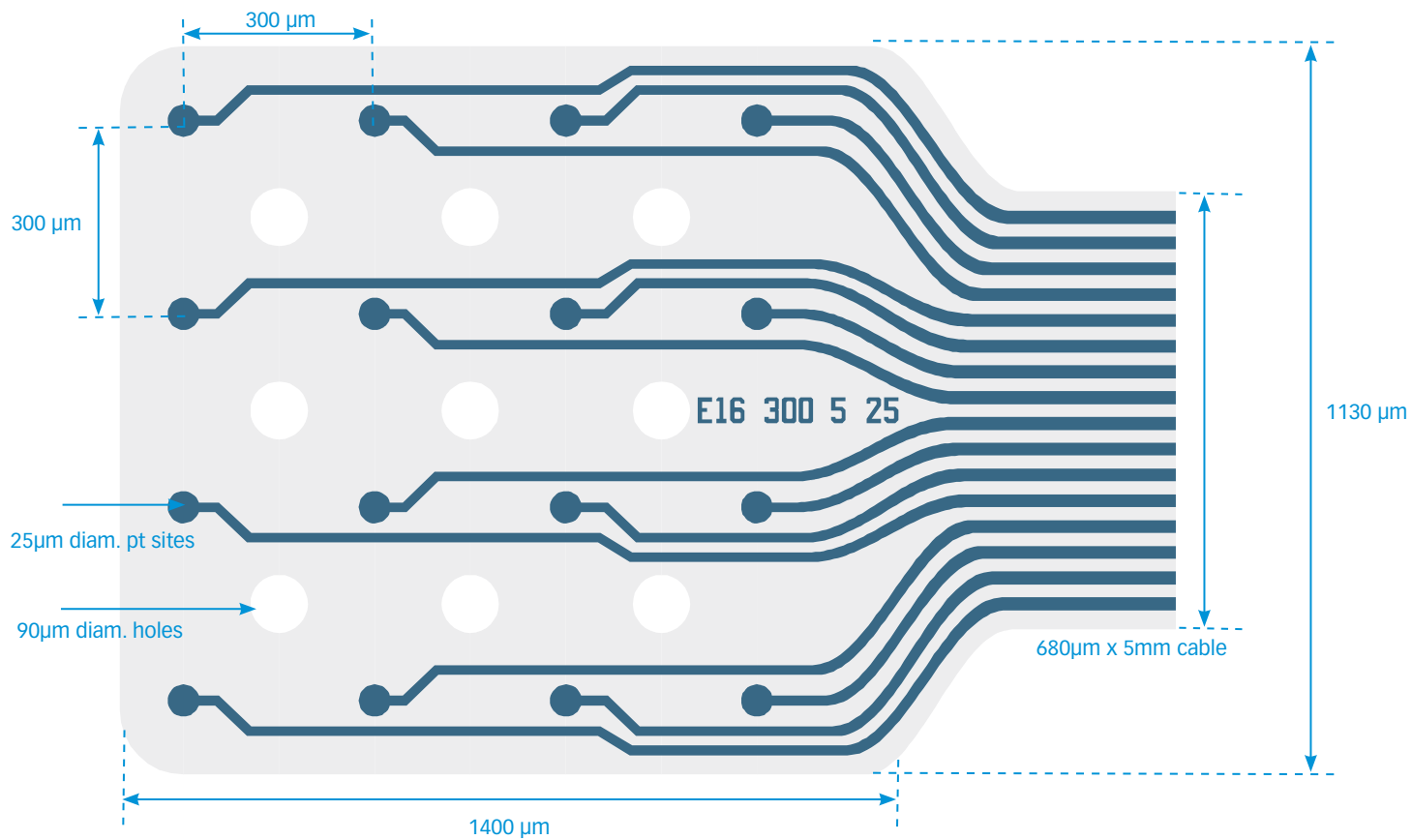

Available packages

CHRONIC

- H16
- HC16
- HZ16
- X3-H16

Thickness

15 μm

E16-500-5-50

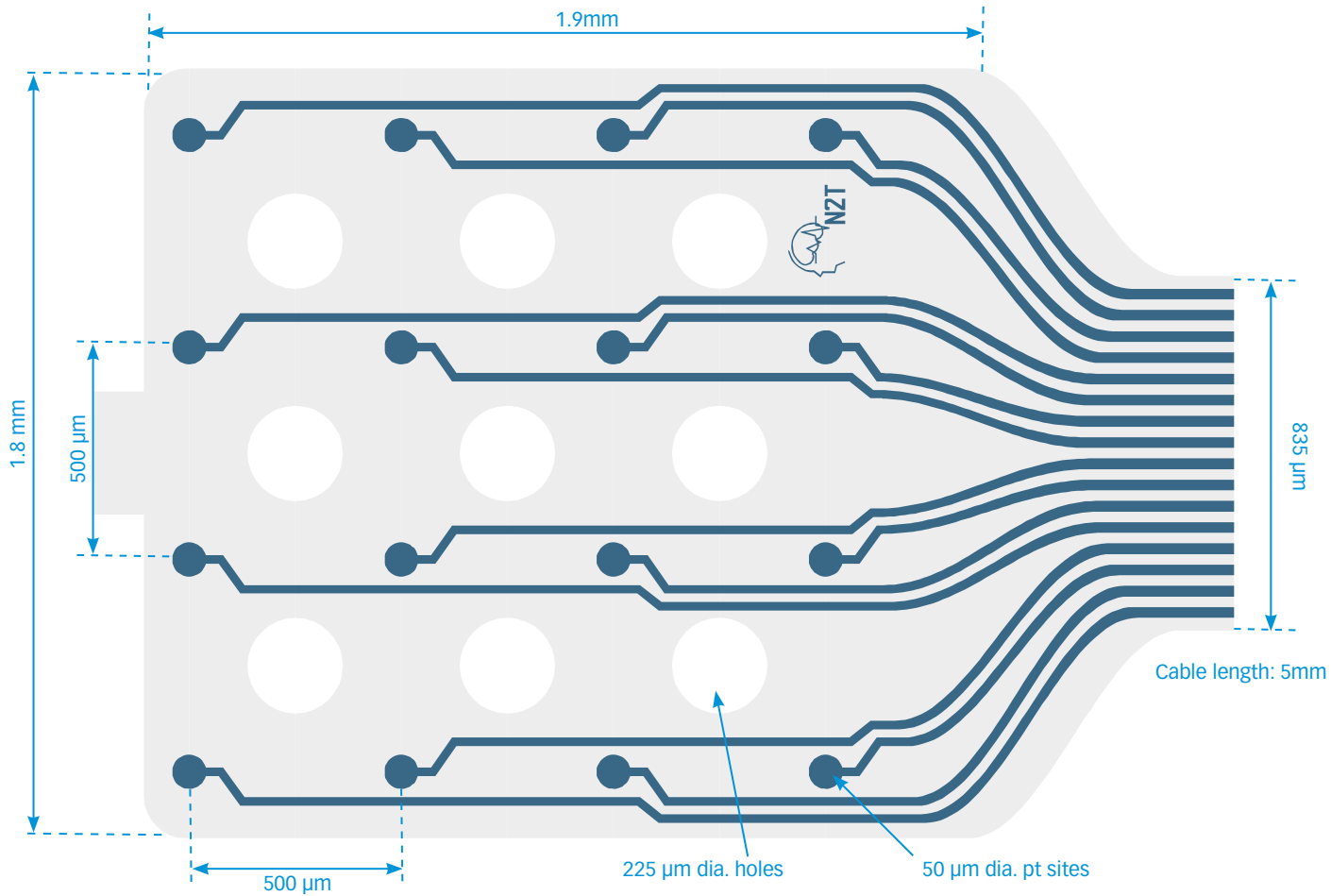

Available packages

CHRONIC

H16
HC16
HZ16
X3-H16

Thickness

15 μ m

E16-500-5-200

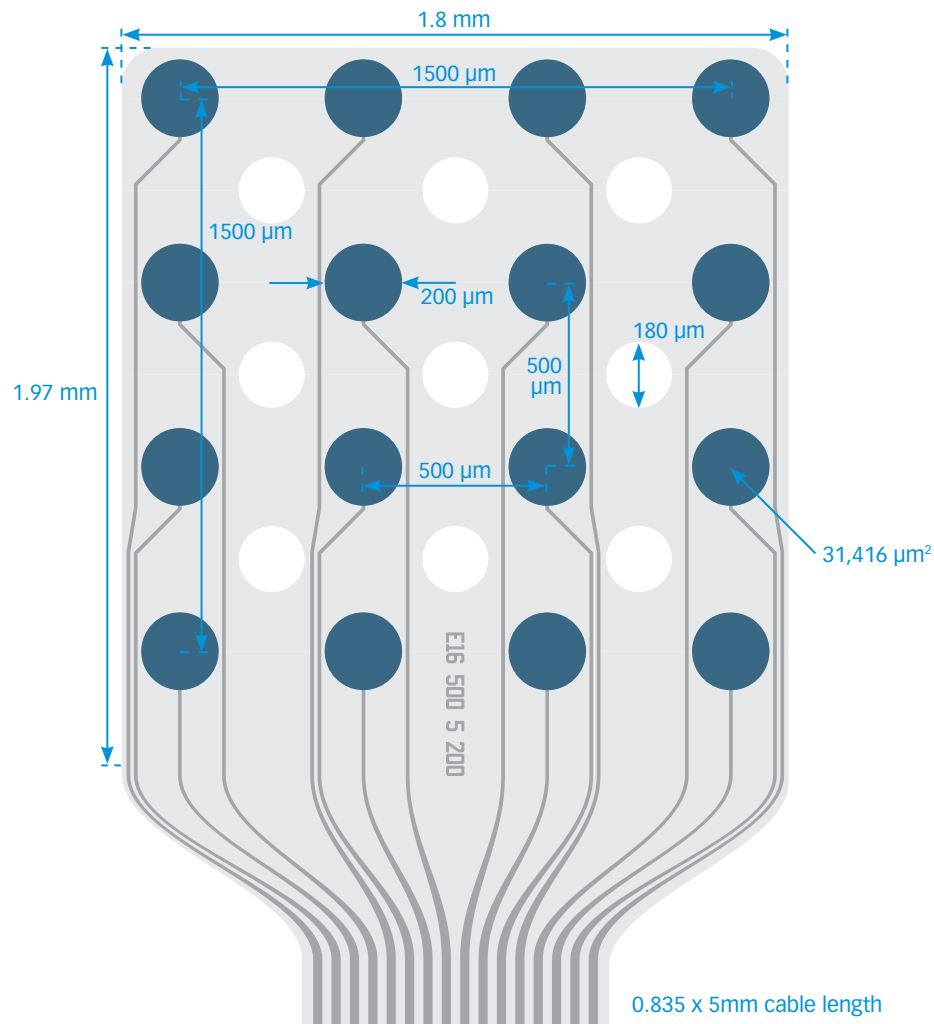

Available packages

CHRONIC

- H16
- HC16
- HZ16
- X3-H16

Thickness

15 μm

E29-80s-25-15

Available packages

CHRONIC

- H16
- HC16
- HZ16
- X3-H16

Thickness

15 μm

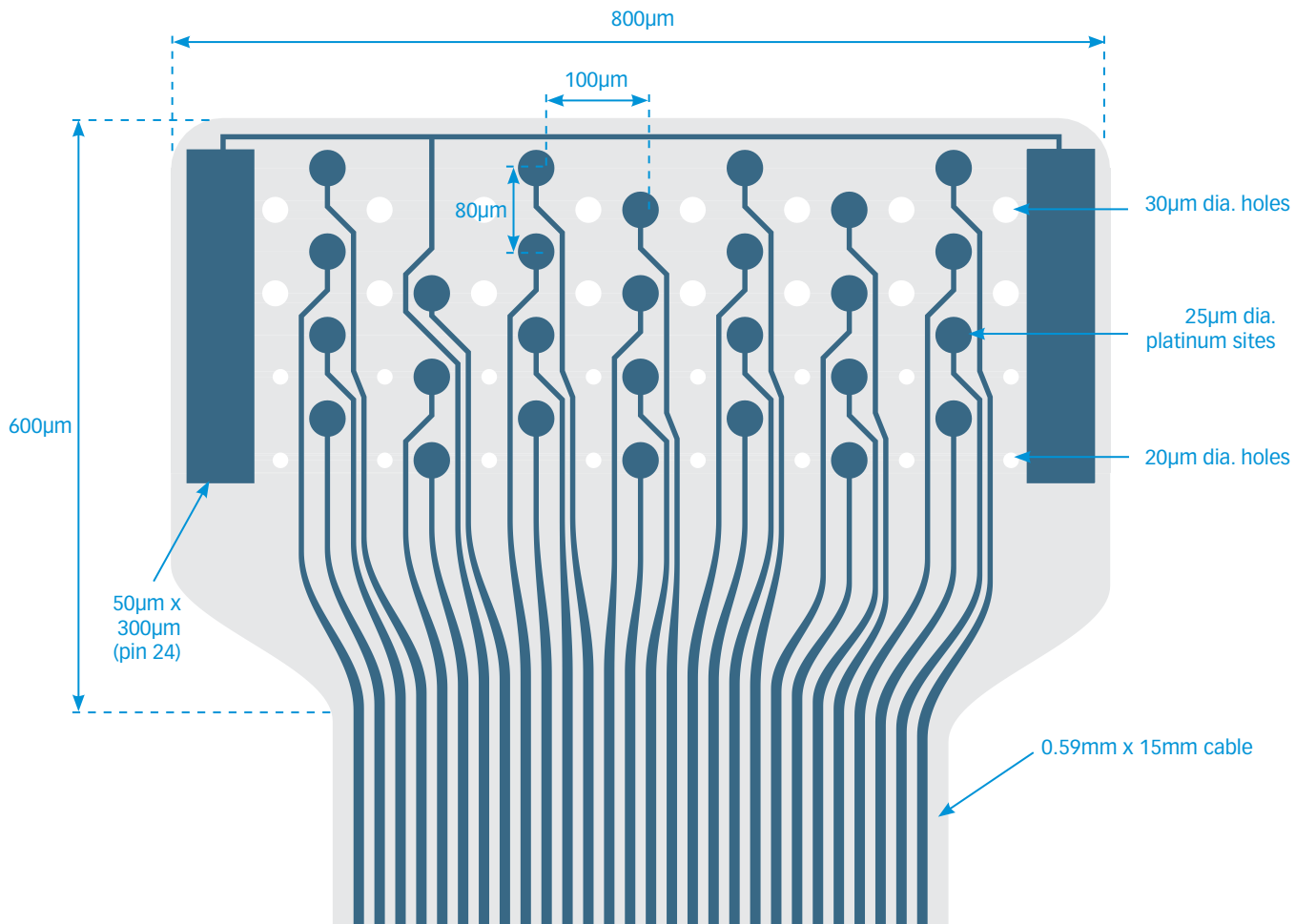

E32-150-70-40

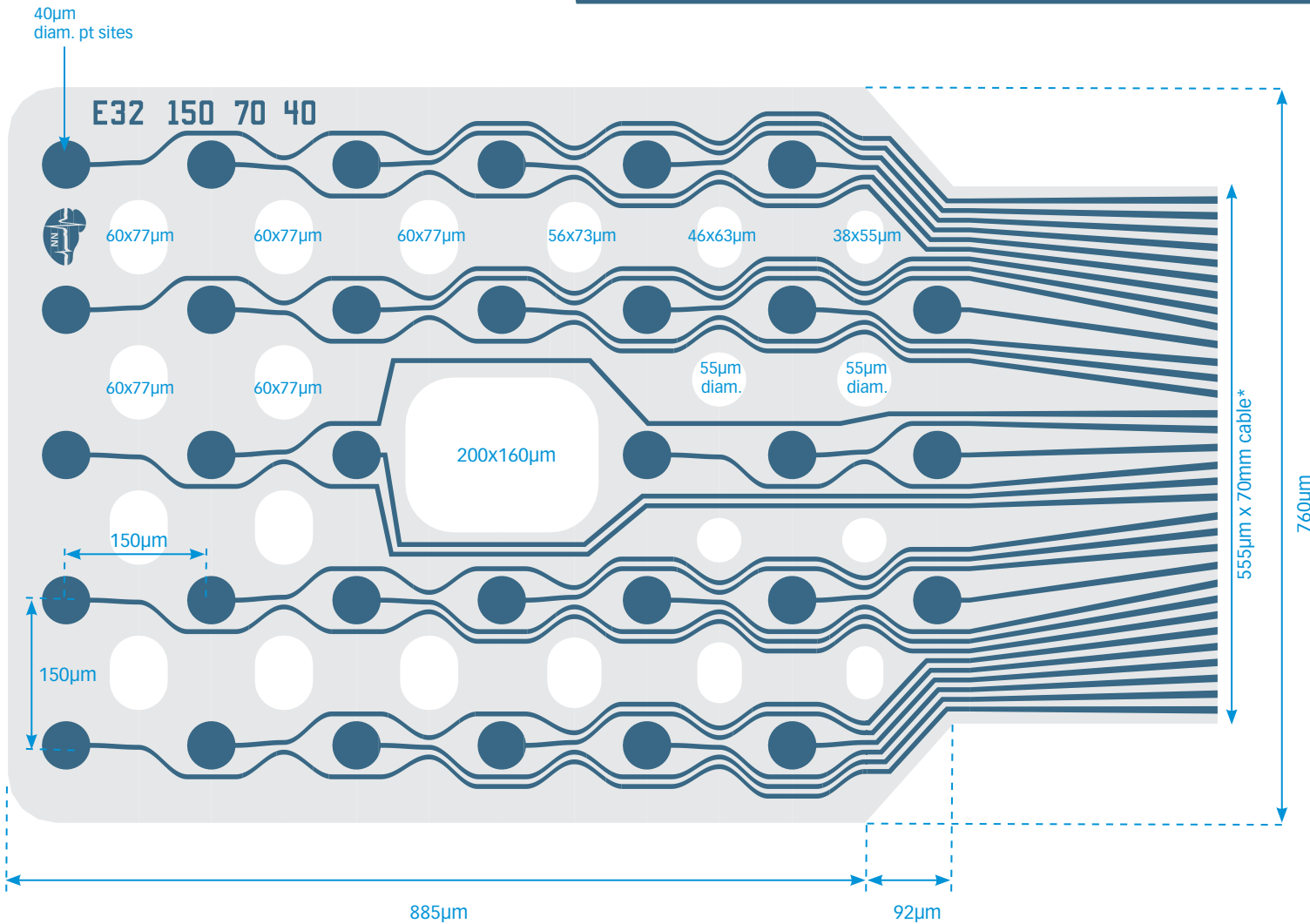

Available packages

CHRONIC

- H32
- HC32
- HZ32
- X3-H32

Thickness

15 µm

E32-250-25-30-PML

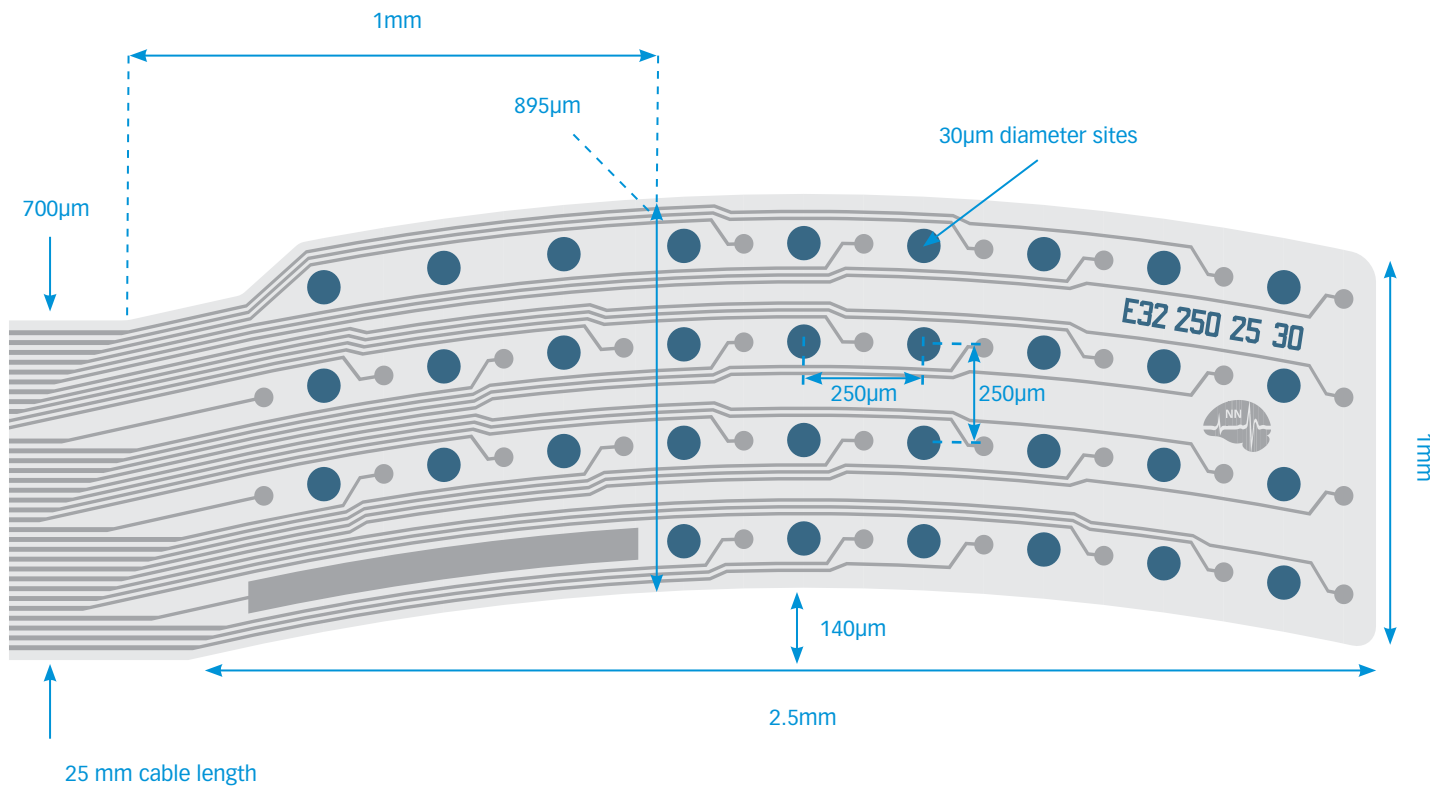

Available packages

CHRONIC

- H32
- HC32
- HZ32
- X3-H32

Thickness

15 µm

E32-300-20-50

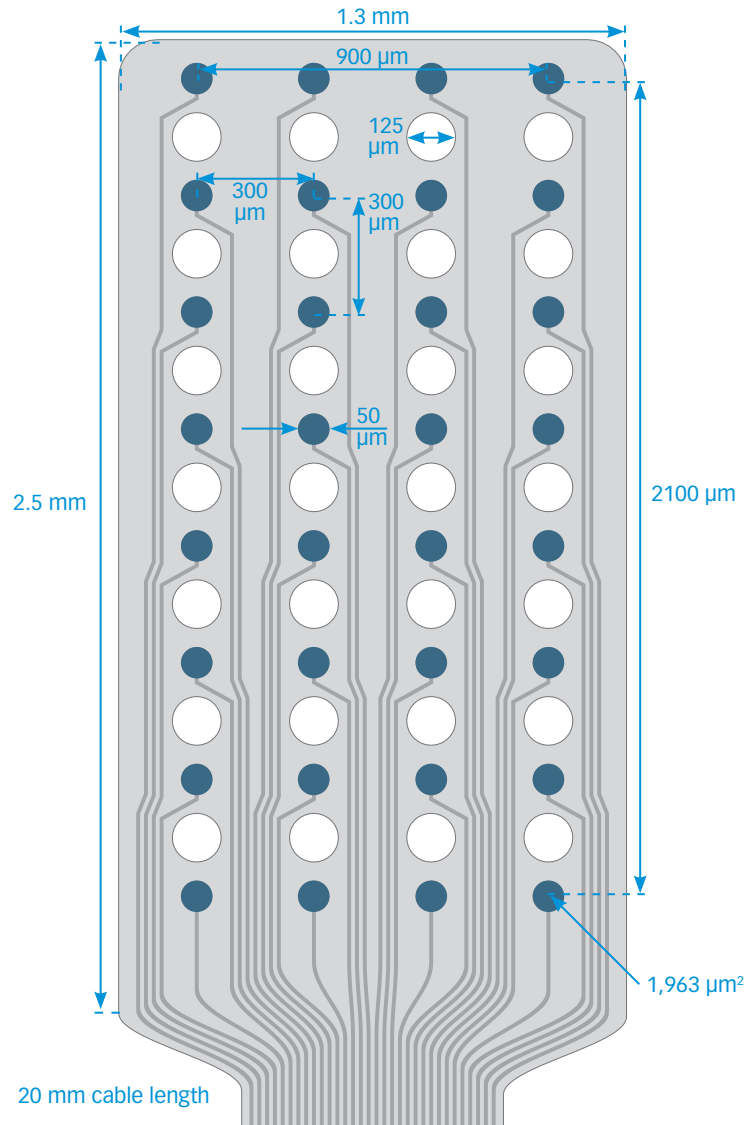

Available packages

CHRONIC

- H32
- HC32
- HZ32
- X3-H32

Thickness

15 μm

E32-600-10-100

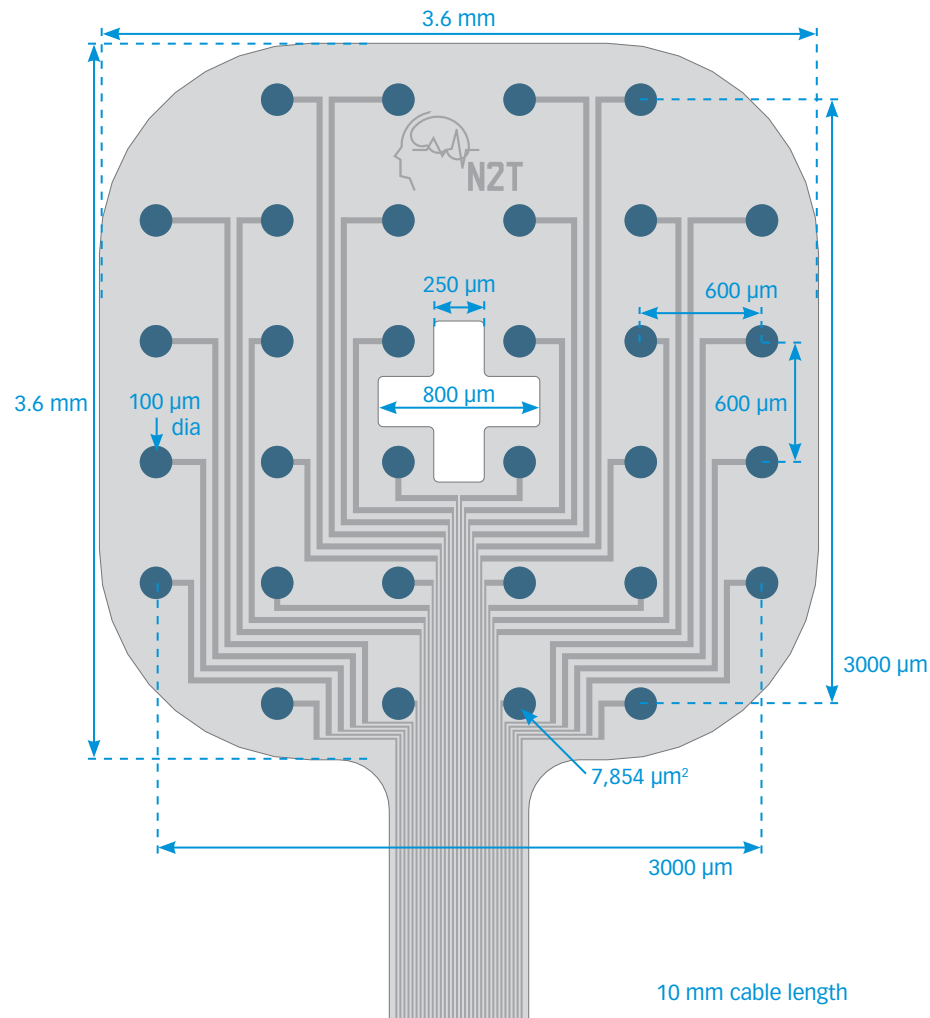

Available packages

CHRONIC

- H32
- HC32
- HZ32
- X3-H32

Thickness

15 μm

E32-750-10-200

Available packages

CHRONIC

- H32
- HC32
- HZ32
- X3-H32

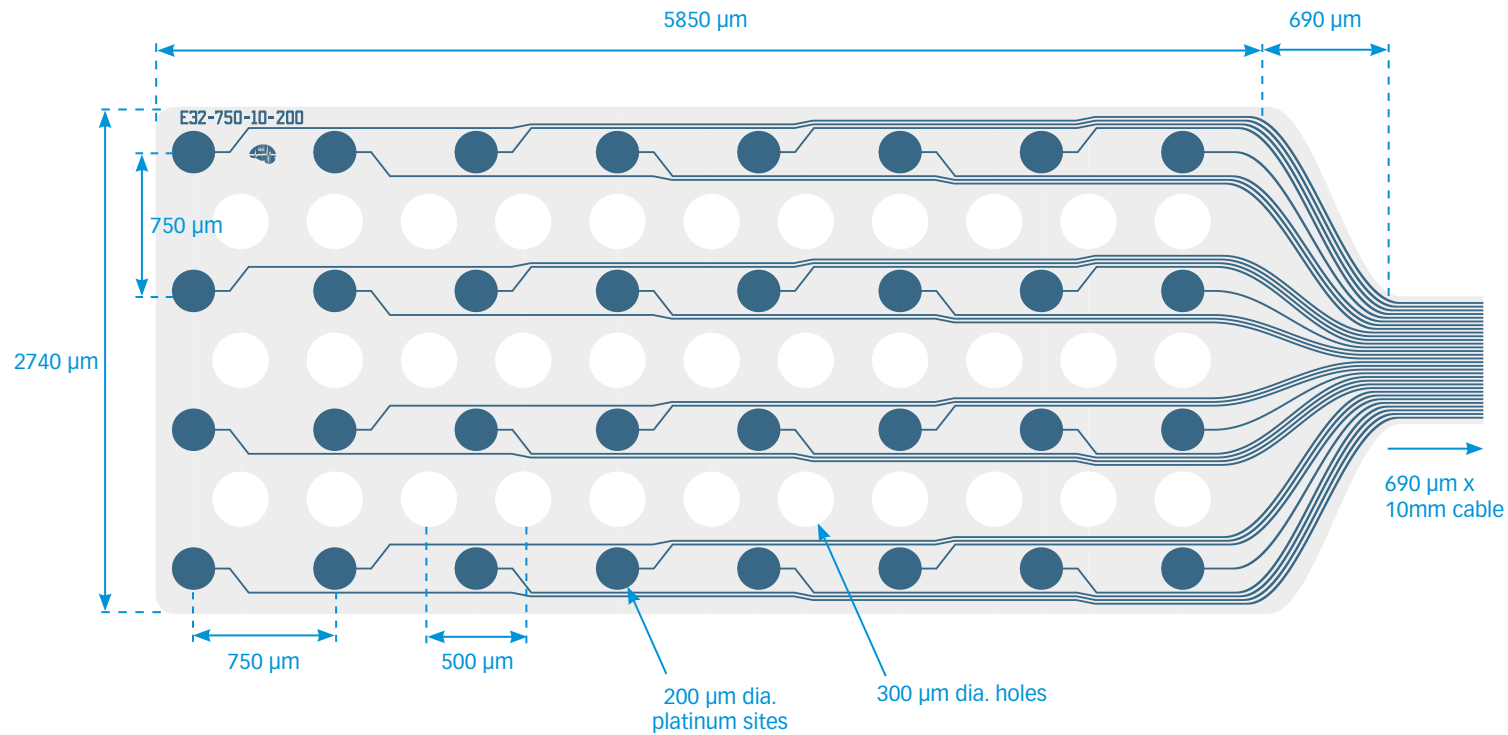

Thickness

15 μm

E32-1000-30-200

Available packages

CHRONIC

H32
HC32
HZ32
X3-H32

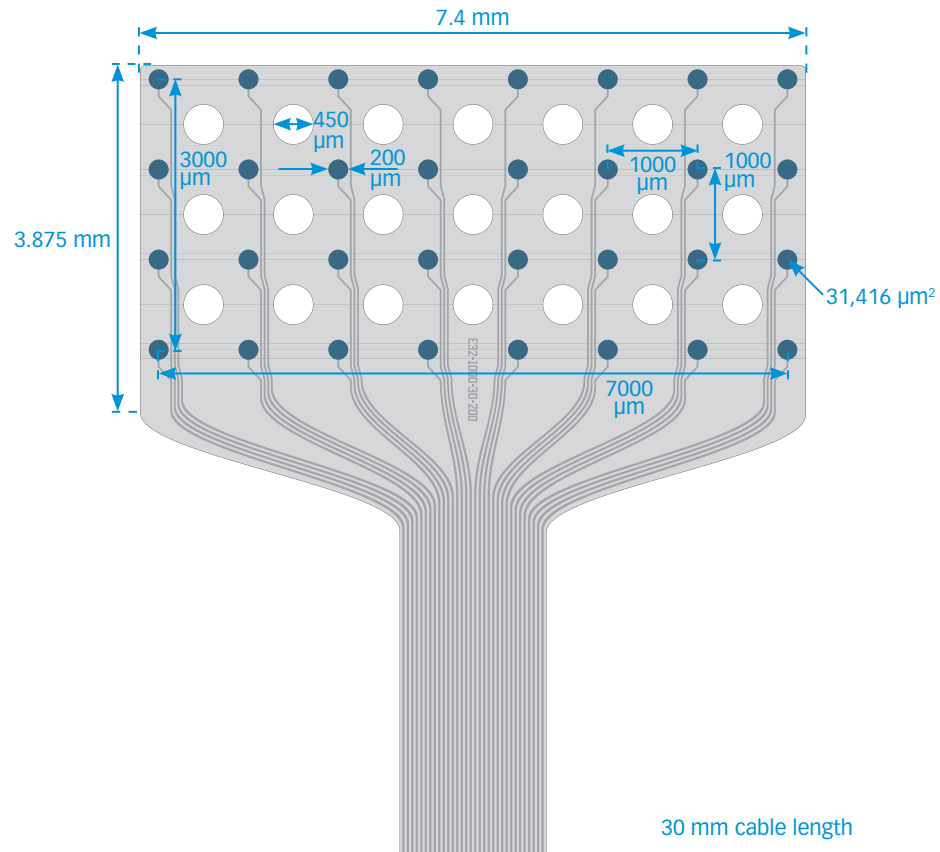

Thickness

15 μm

E32-1000-20-50/100

Available packages

CHRONIC

- H32
- HC32
- HZ32
- X3-H32

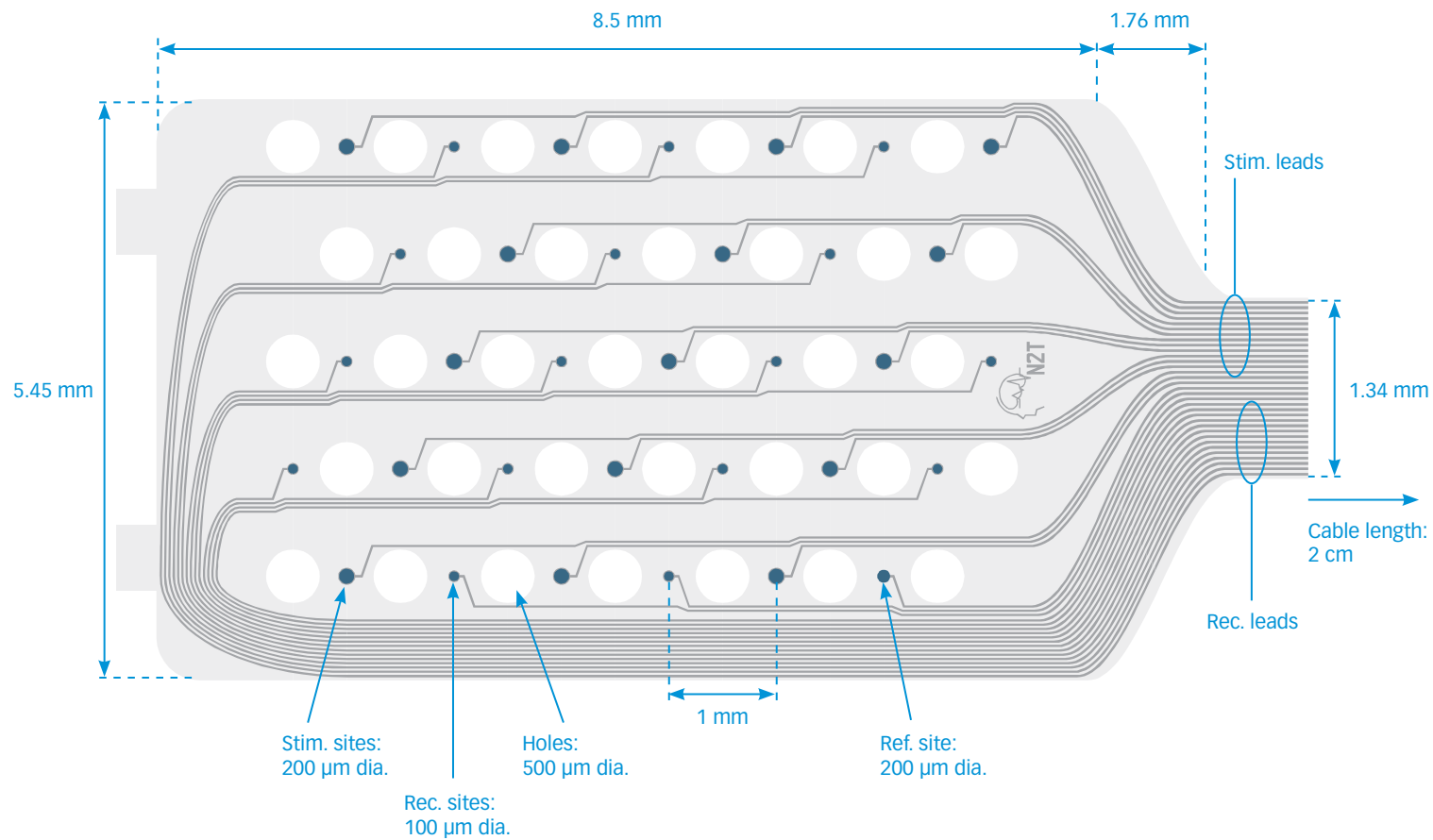

Thickness

15 μm

E32-1000-30-50

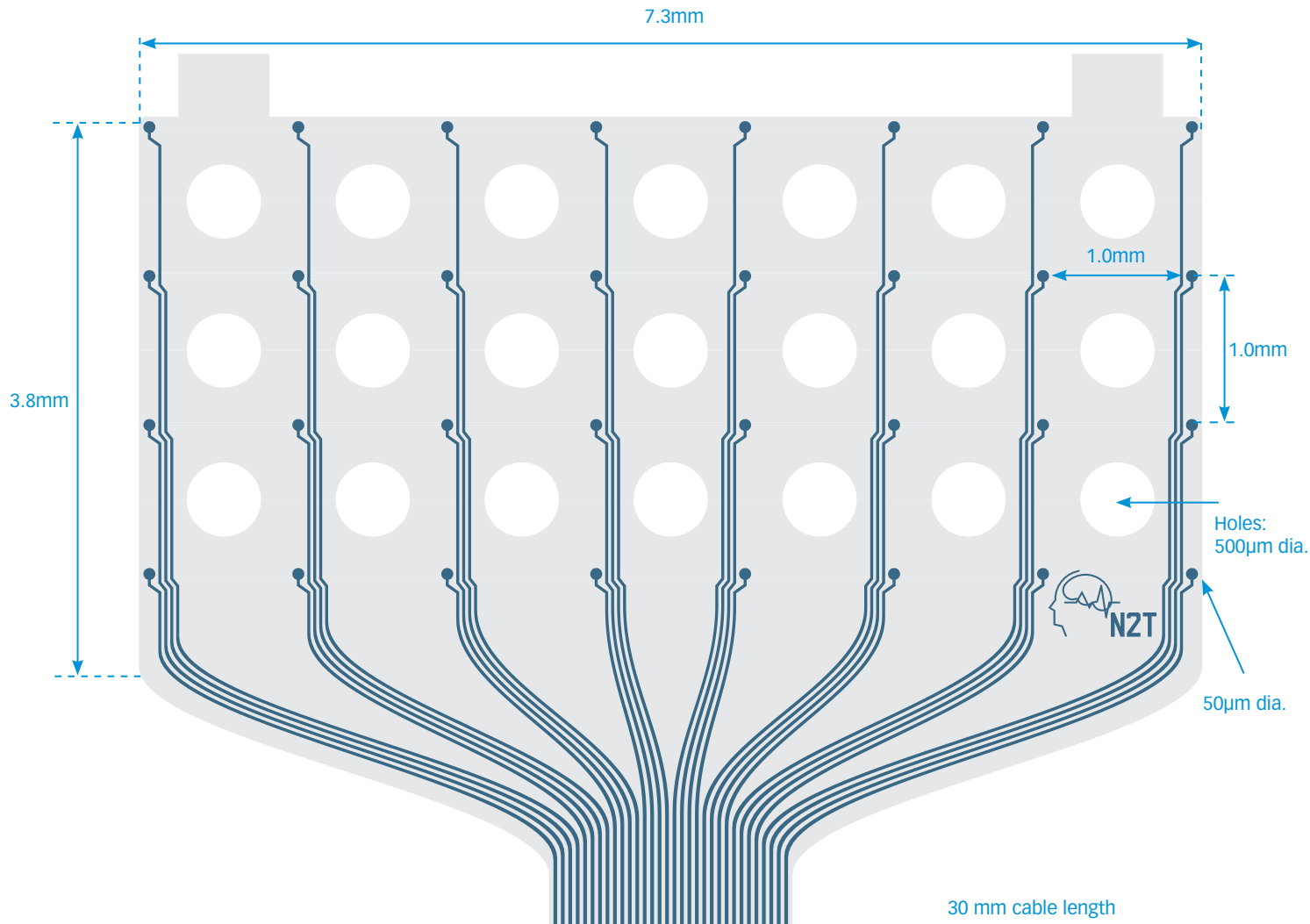

Available packages

CHRONIC

- H32
- HC32
- HZ32
- X3-H32

Thickness

15 µm

E32-3000-20-300

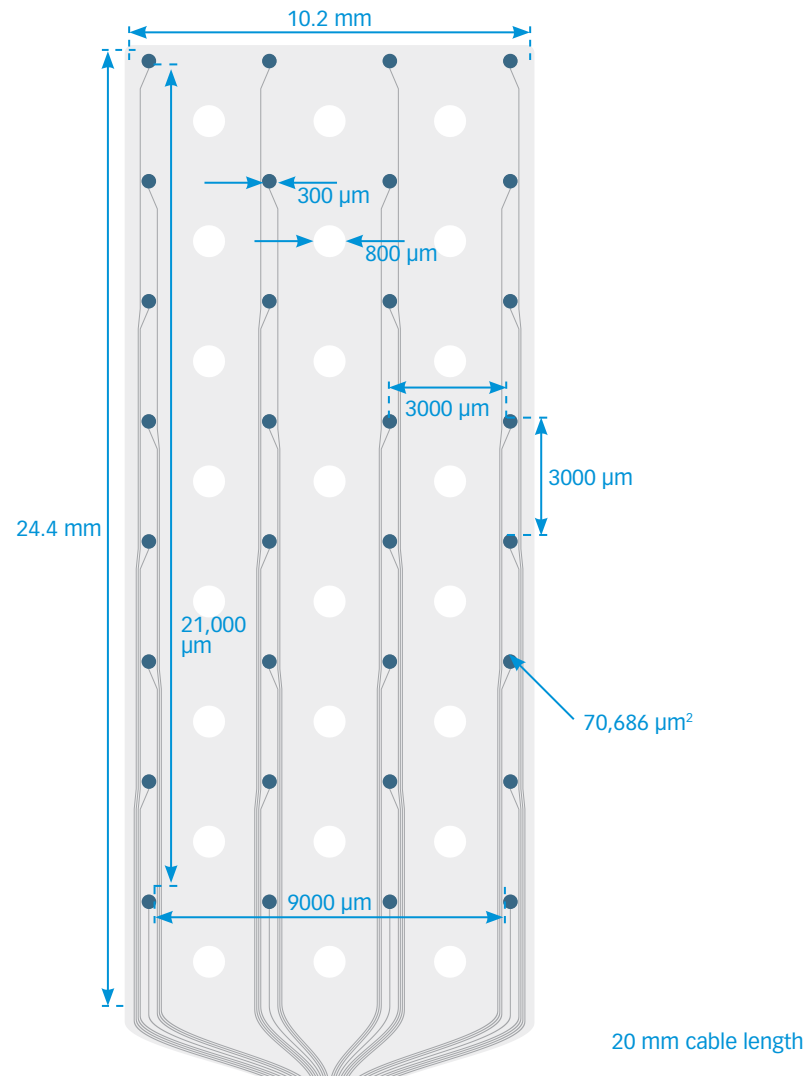

Available packages

CHRONIC

- H32
- HC32
- HZ32
- X3-H32

Thickness

15 μm

E32-3000-6000-30-500

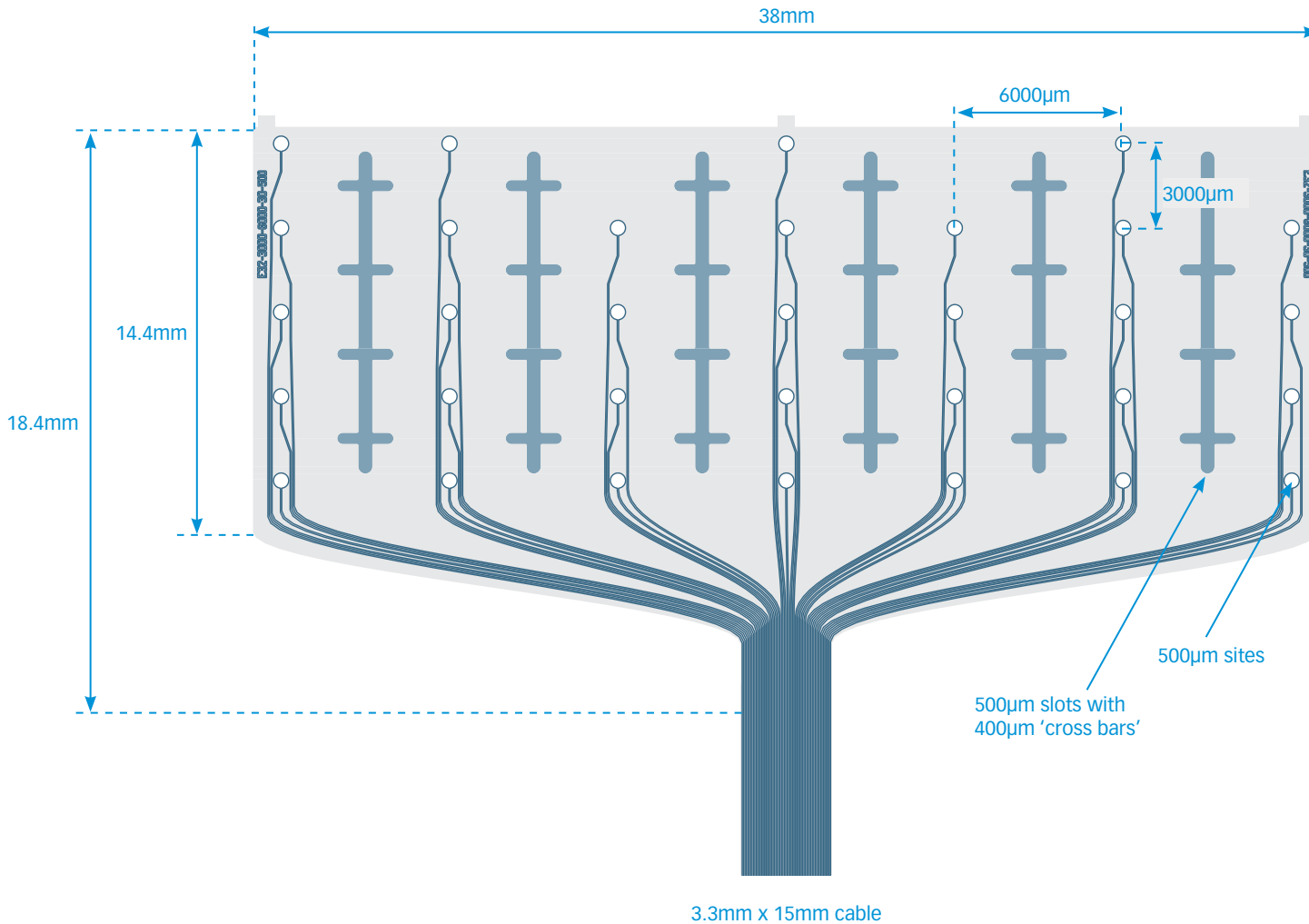

Available packages

CHRONIC

- H32
- HC32
- HZ32
- X3-H32

Thickness

15 µm

E64-400-60-40

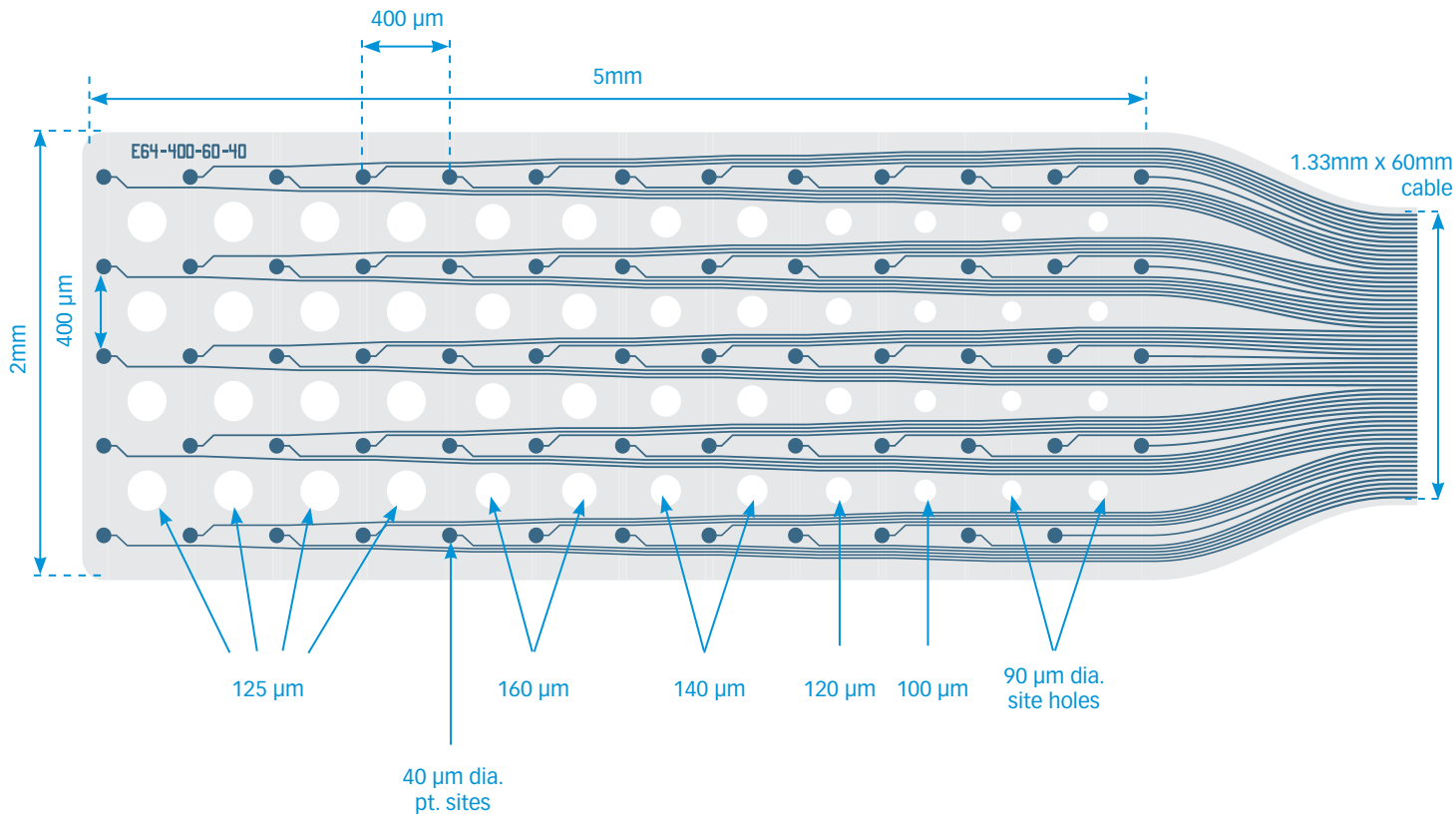

Available packages

CHRONIC

- H64
- H64LP
- HC64
- HZ64
- X3-H64

Thickness

15 μm

E64-400-500-50-50

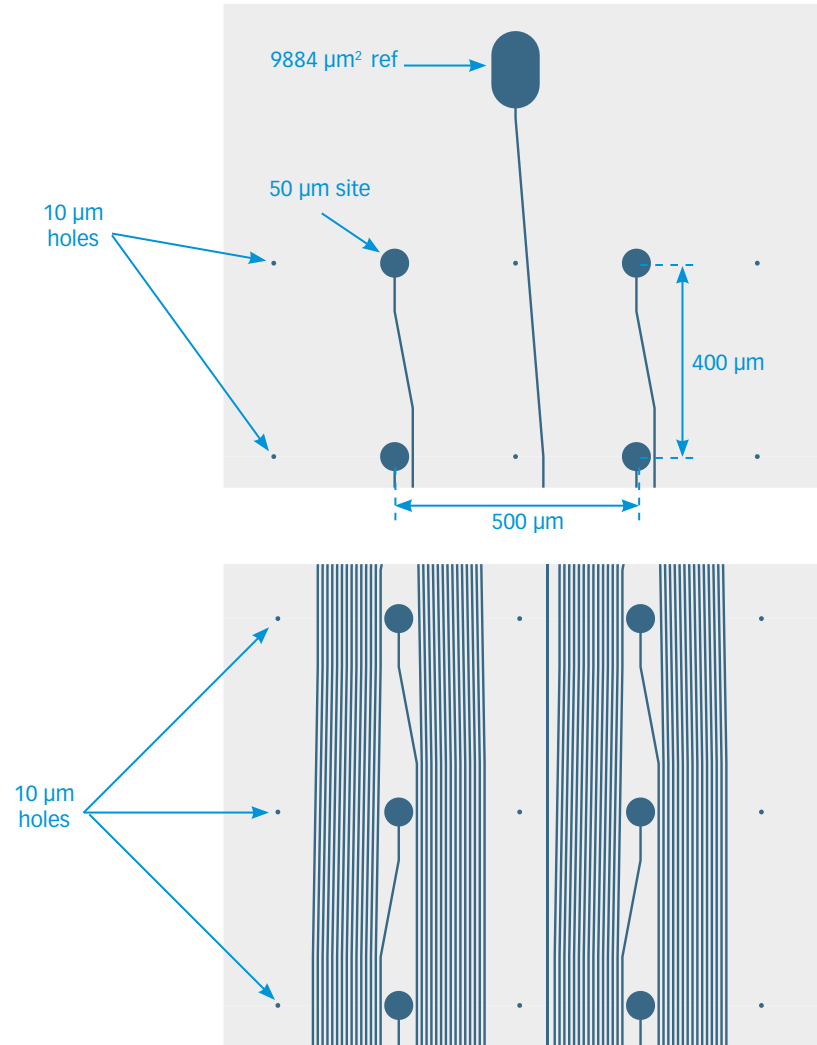
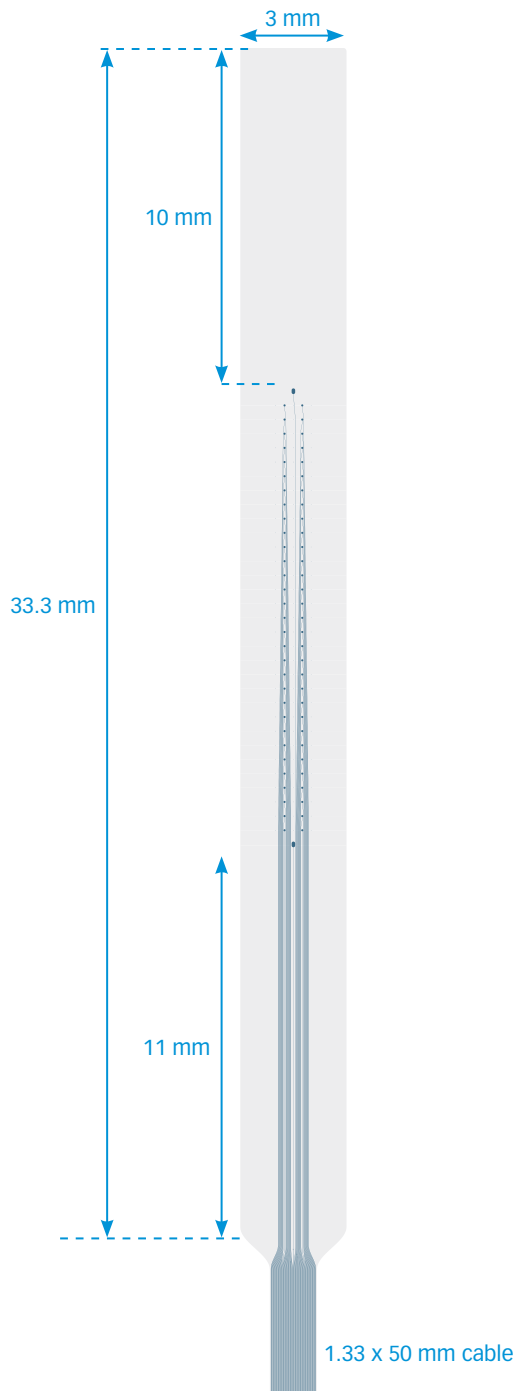

Available packages

- CHRONIC**
- H64
- H64LP
- HC64
- HZ64
- X3-H64

Thickness

15 μm

E64-500-20-60

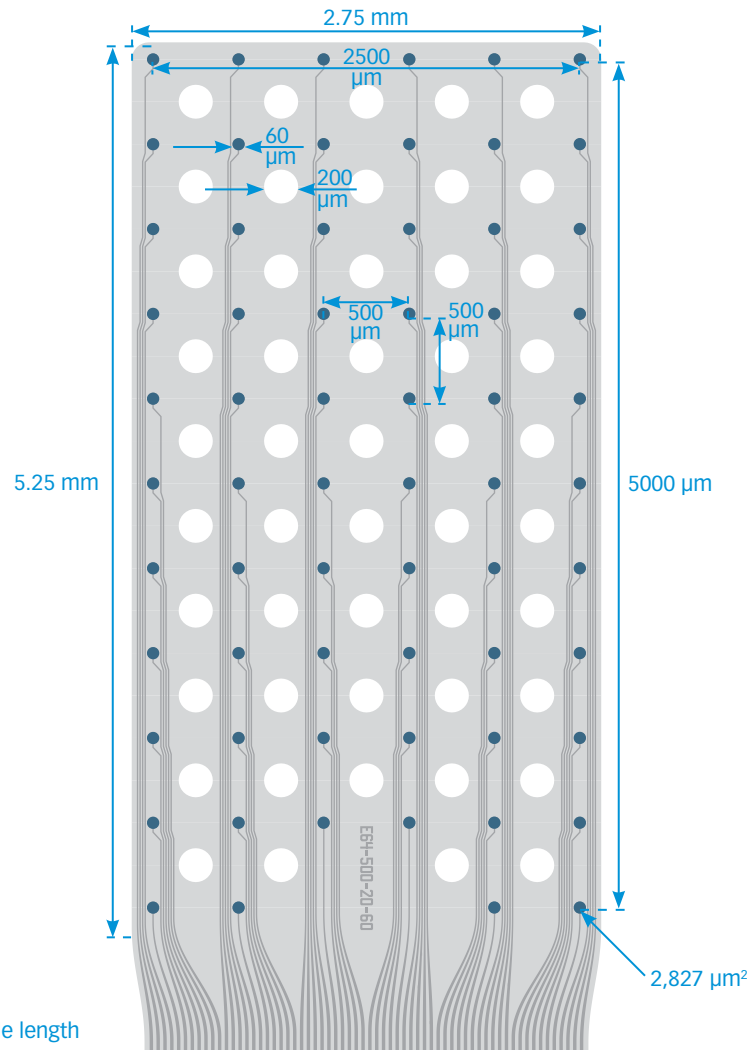

Available packages

CHRONIC

- H64
- H64LP
- HC64
- HZ64
- X3-H64

Thickness

15 μm

E64-500-25-100

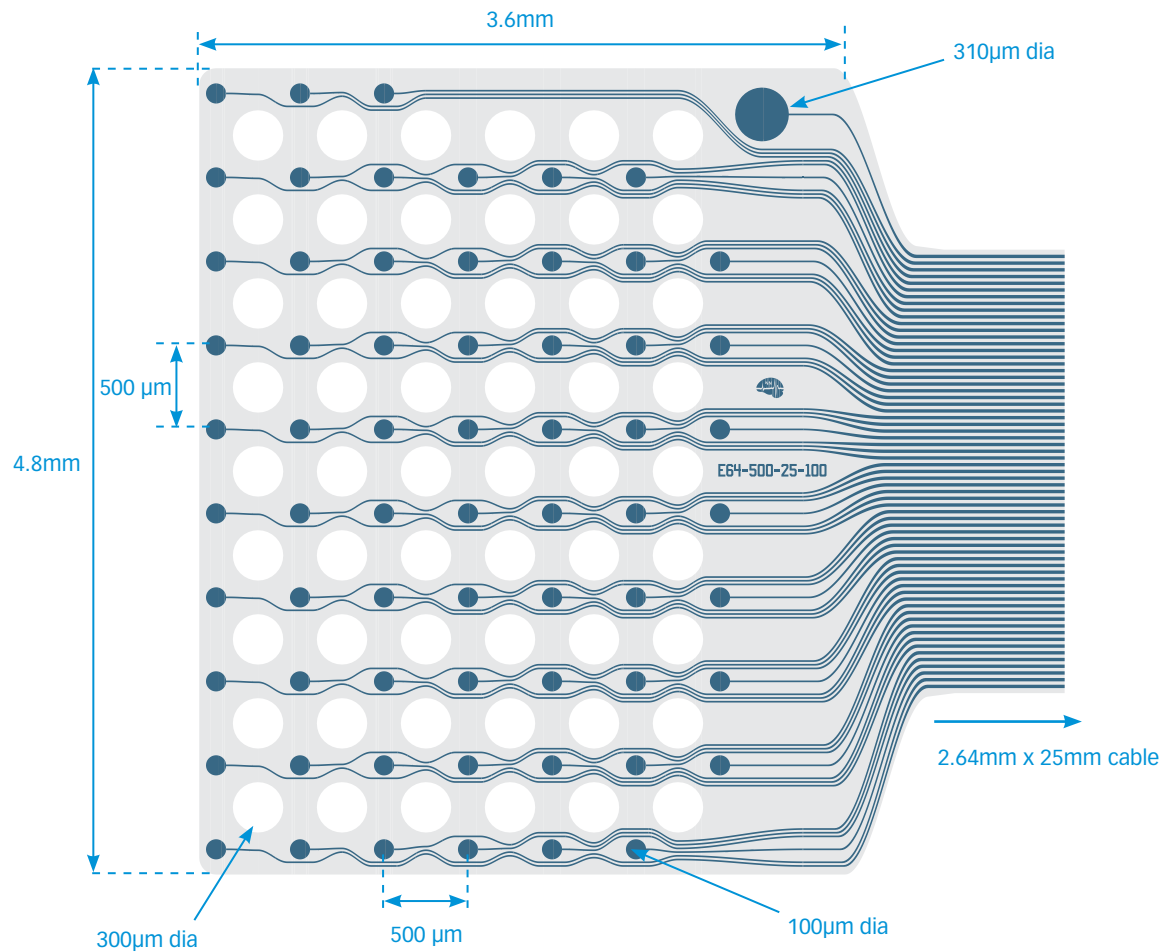

Available packages

CHRONIC

- H64
- H64LP
- HC64
- HZ64
- X3-H64

Thickness

15 μm

E64-500-80-60

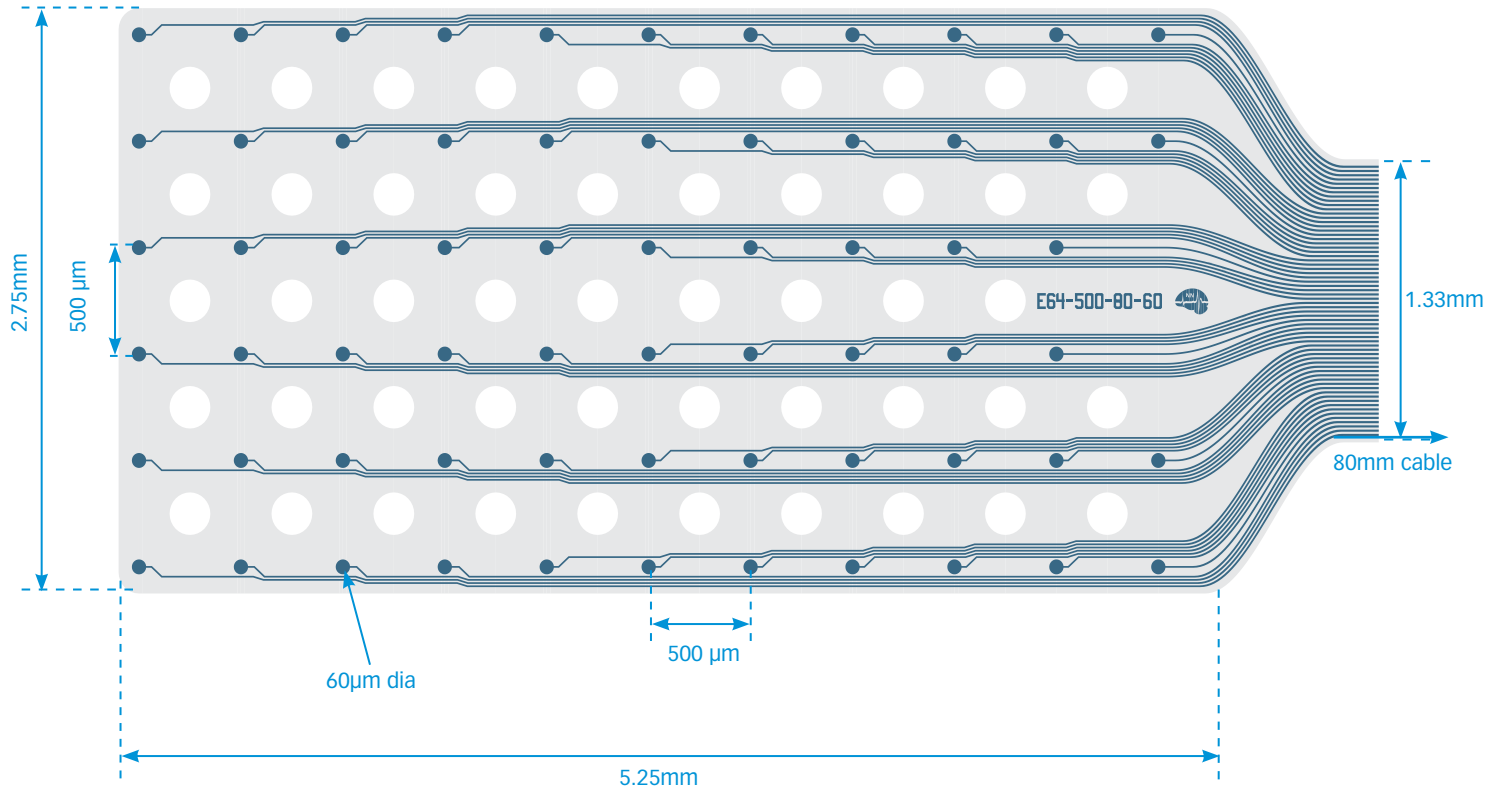

Available packages

CHRONIC

- H64
- H64LP
- HC64
- HZ64
- X3-H64

Thickness

15 μm

E64-1000-50-200

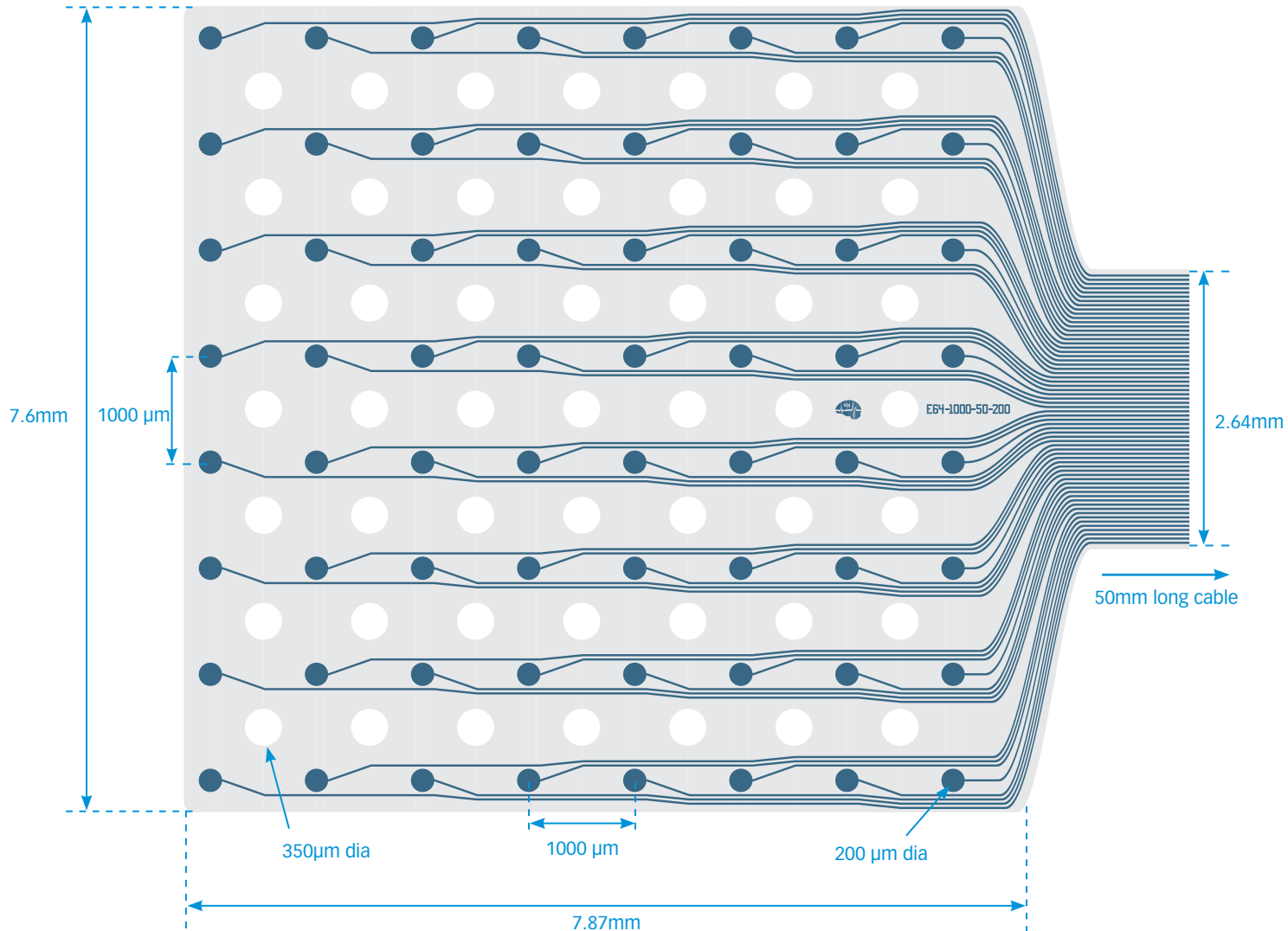

Available packages

CHRONIC

- H64
- H64LP
- HC64
- HZ64
- X3-H64

Thickness

15 µm

E64-2500-50-200

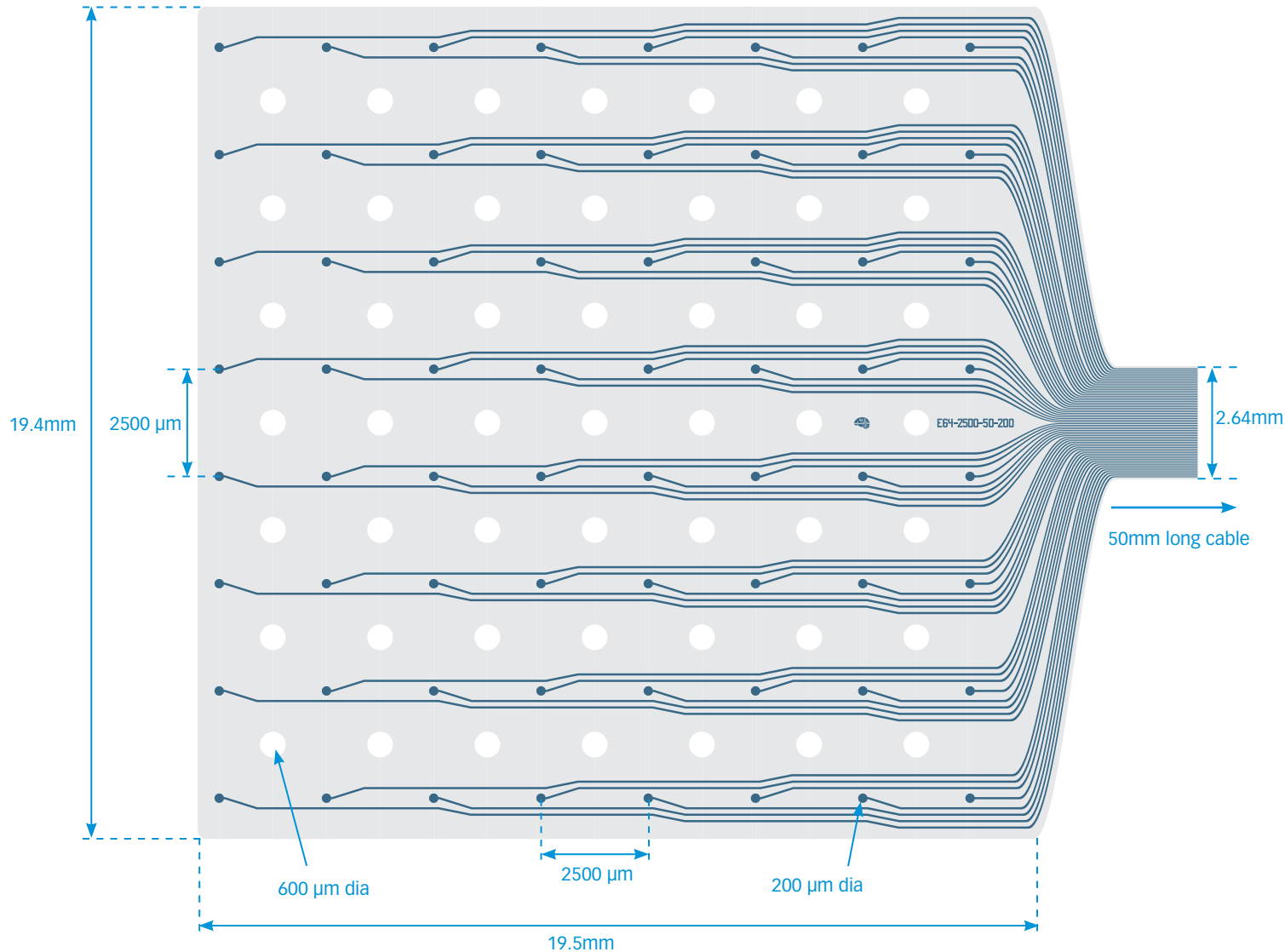

Available packages

CHRONIC

- H64
- H64LP
- HC64
- HZ64
- X3-H64

Thickness

15 μm

E120-2000-100-1000

Cable will be folded to achieve 100mm length, leading to overall device length of 180mm (includes distal area with holes)

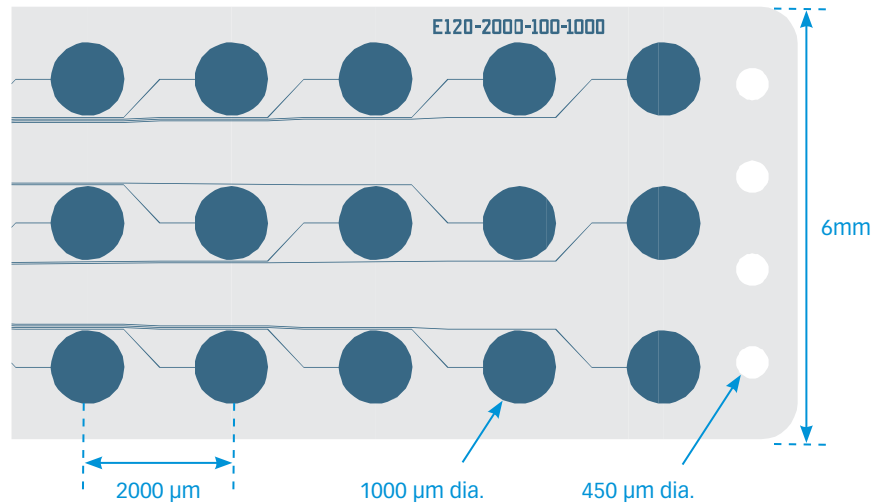
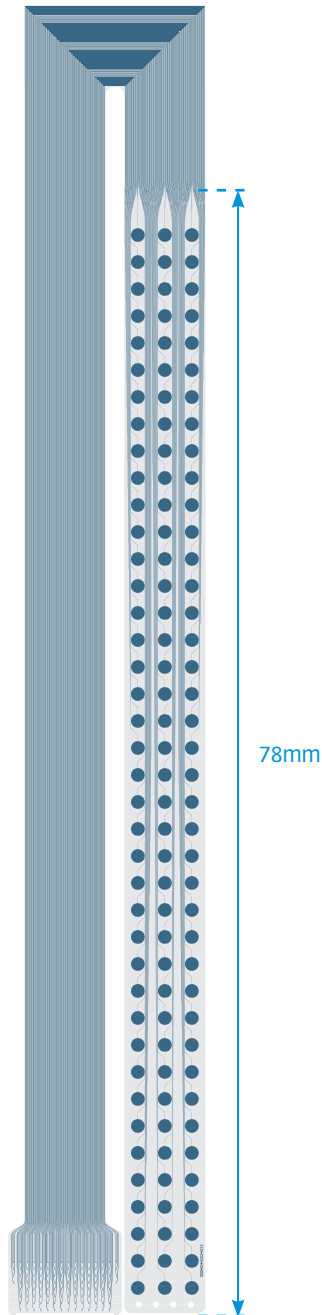

Available packages

CHRONIC

- H128
- H128LP
- IH128
- AVH128
- AVIH128

Thickness

15 μm

E128-150-186-20-60

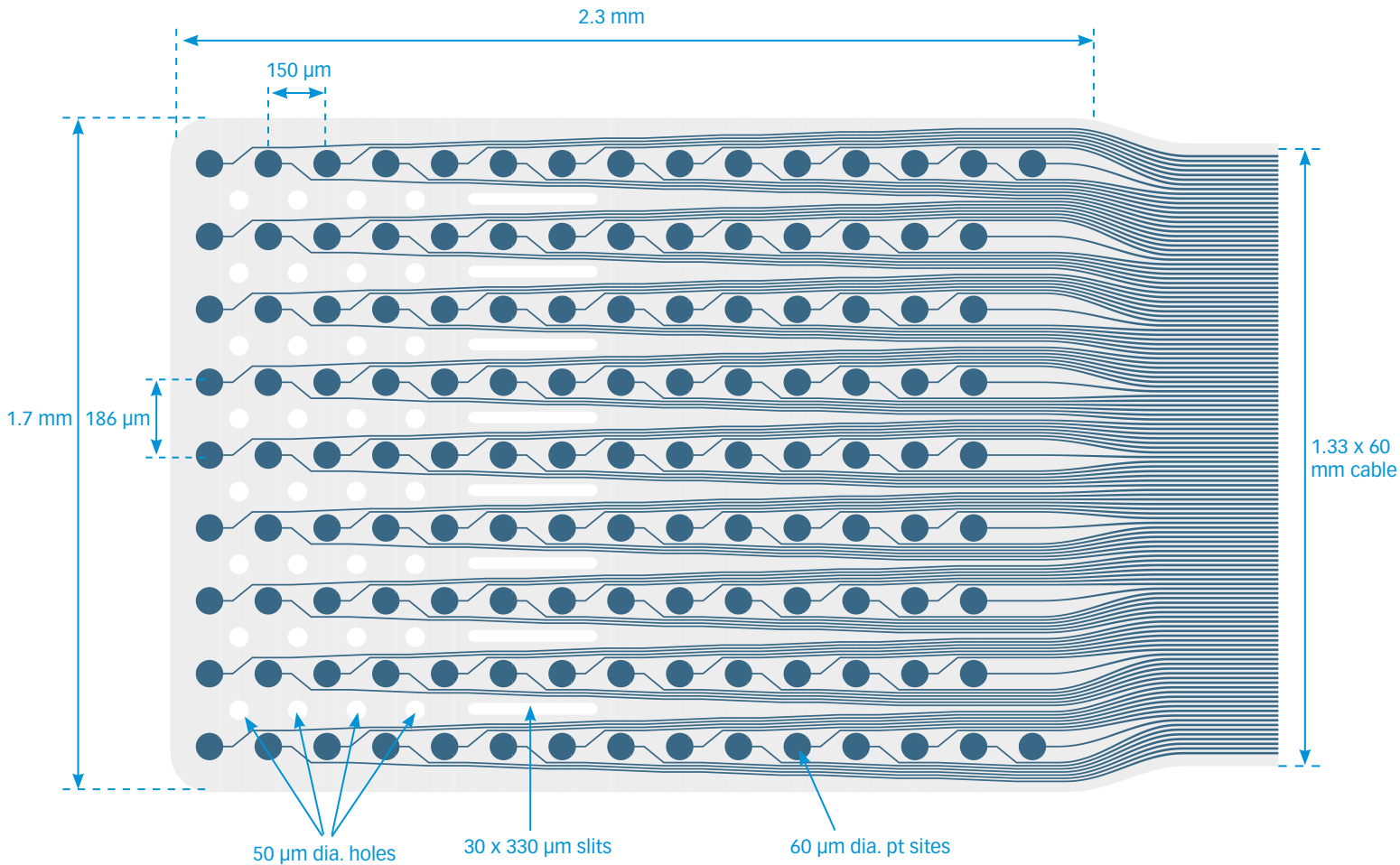

Available packages

CHRONIC

- H128
- H128LP
- IH128
- AVH128
- AVIH128

Thickness

15 μm

E128-200-8-40

Available packages

CHRONIC

- H128
- H128LP
- IH128
- AVH128
- AVIH128

Thickness

15 μ m

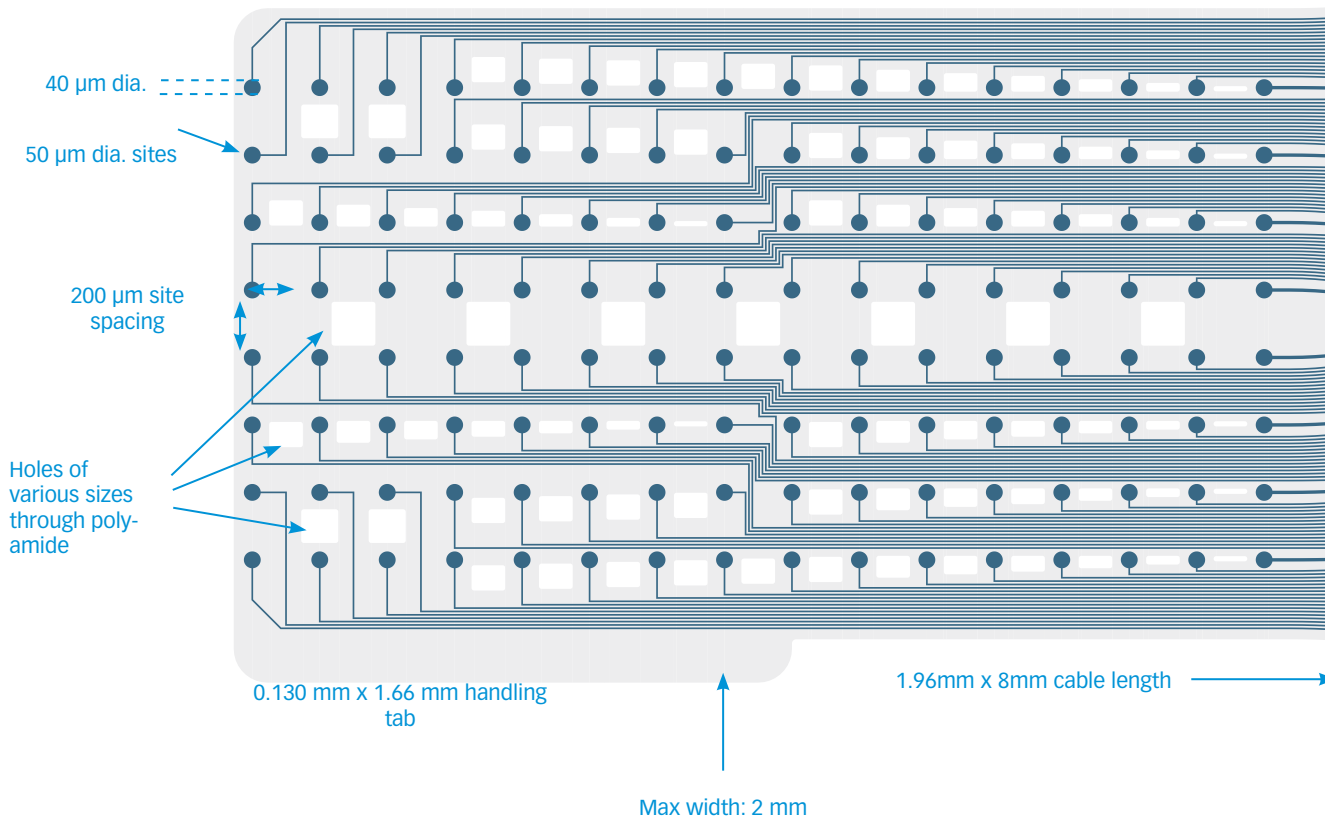

E128-1000-1000-60-200

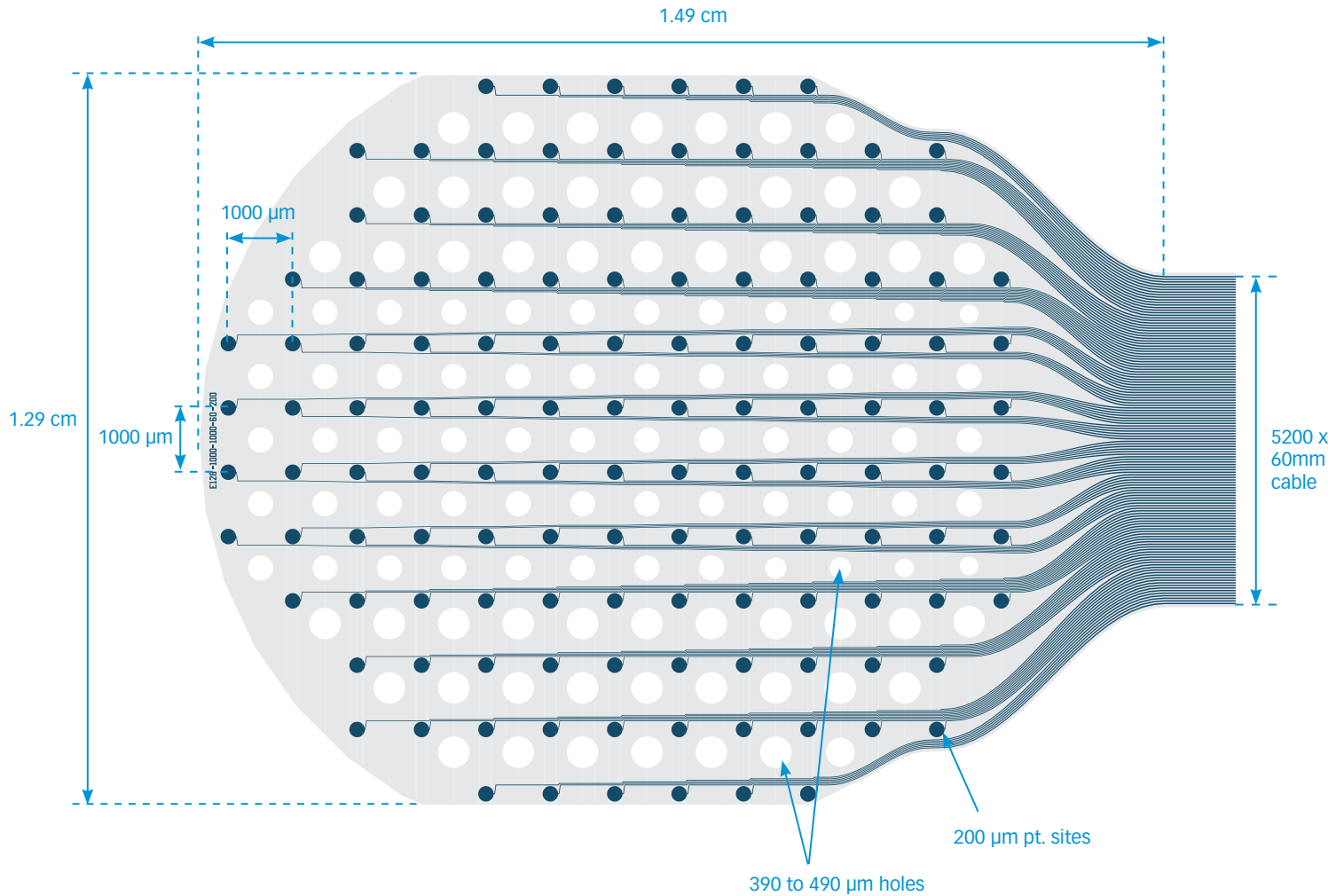

Available packages

CHRONIC

- H128
- H128LP
- IH128
- AVH128
- AVIH128

Thickness

15 μm

E128-1000-80-100

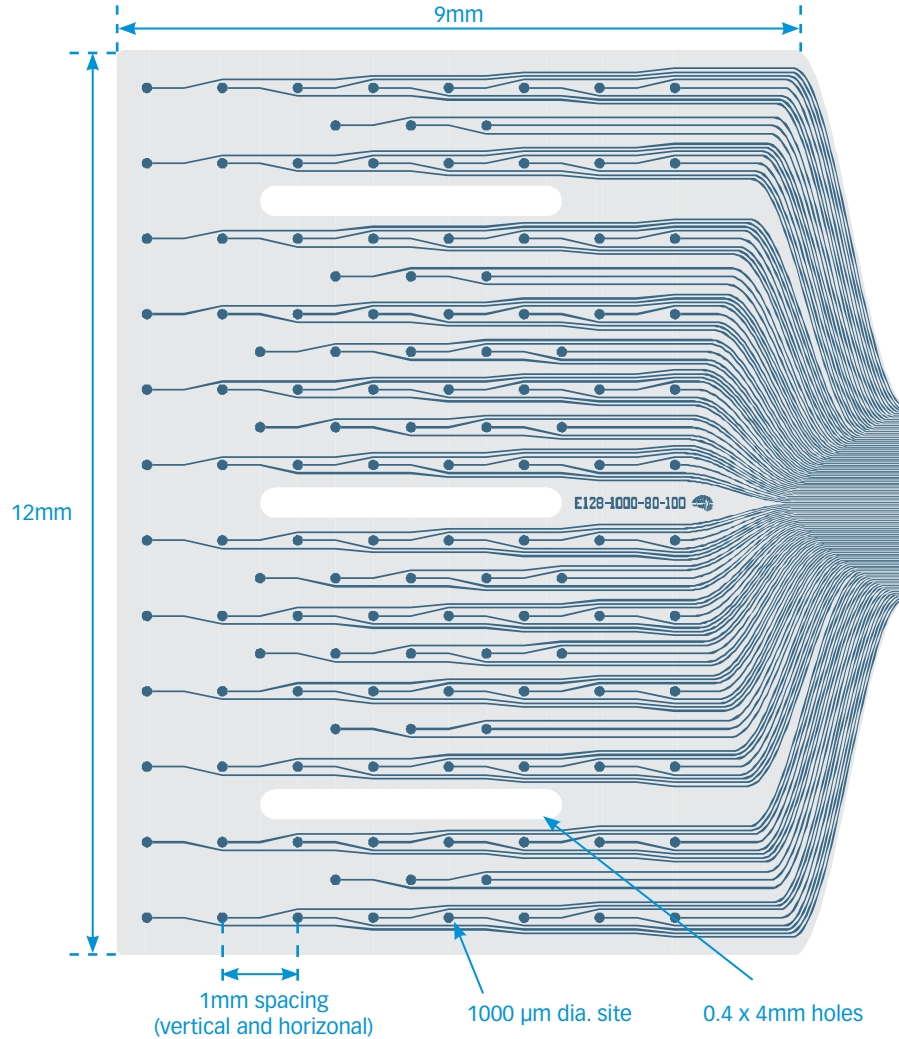
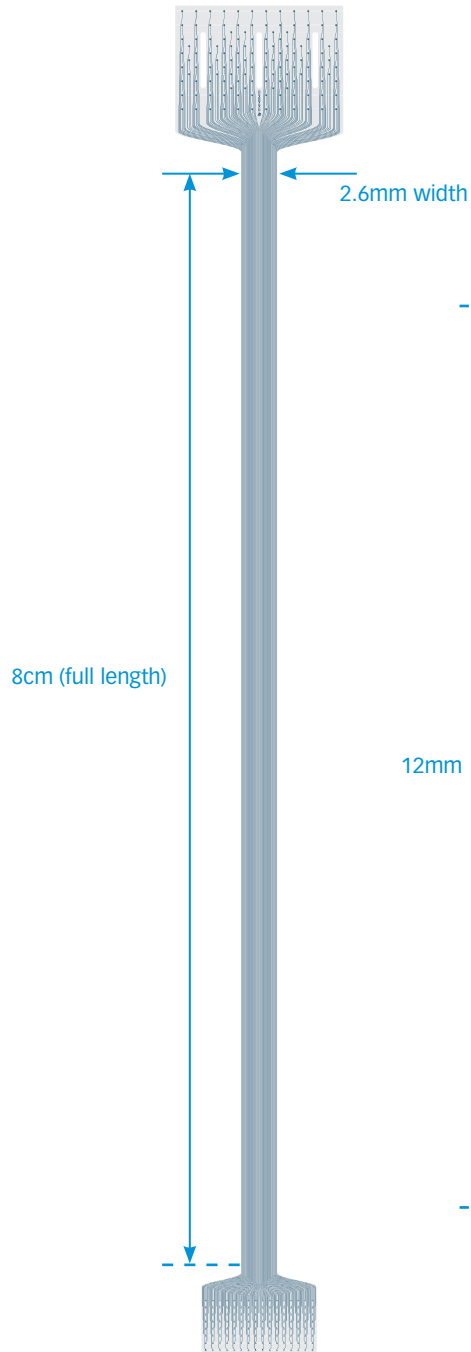

TIP DETAIL

Available packages

CHRONIC

- H128
- H128LP
- IH128
- AVH128
- AVIH128

Thickness

15 μ m

E252-300-30-150

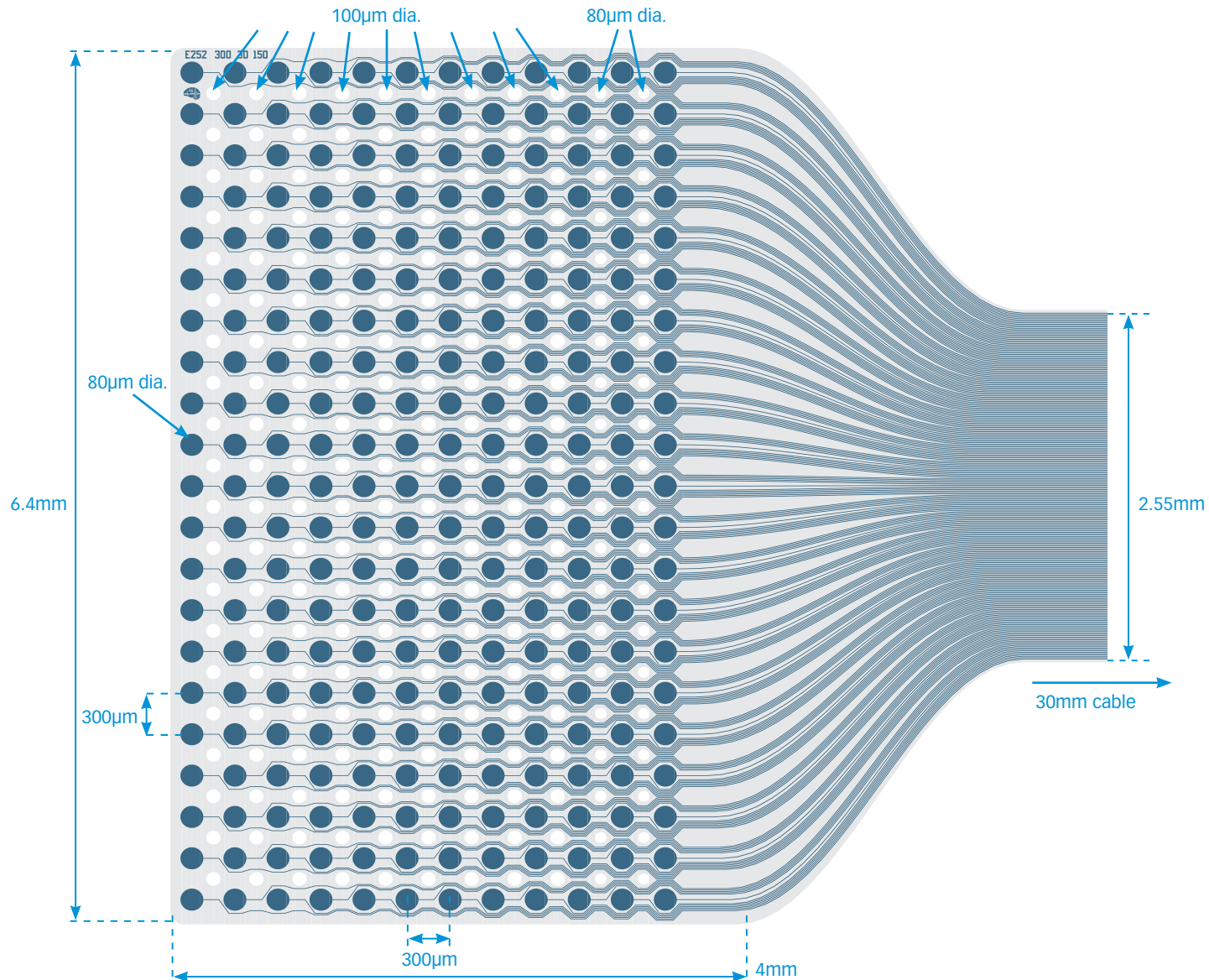

Available packages

CHRONIC
AVIH128
H256
IH256
AVH256
AVIH256

Thickness

15 µm

E256-200-30-80

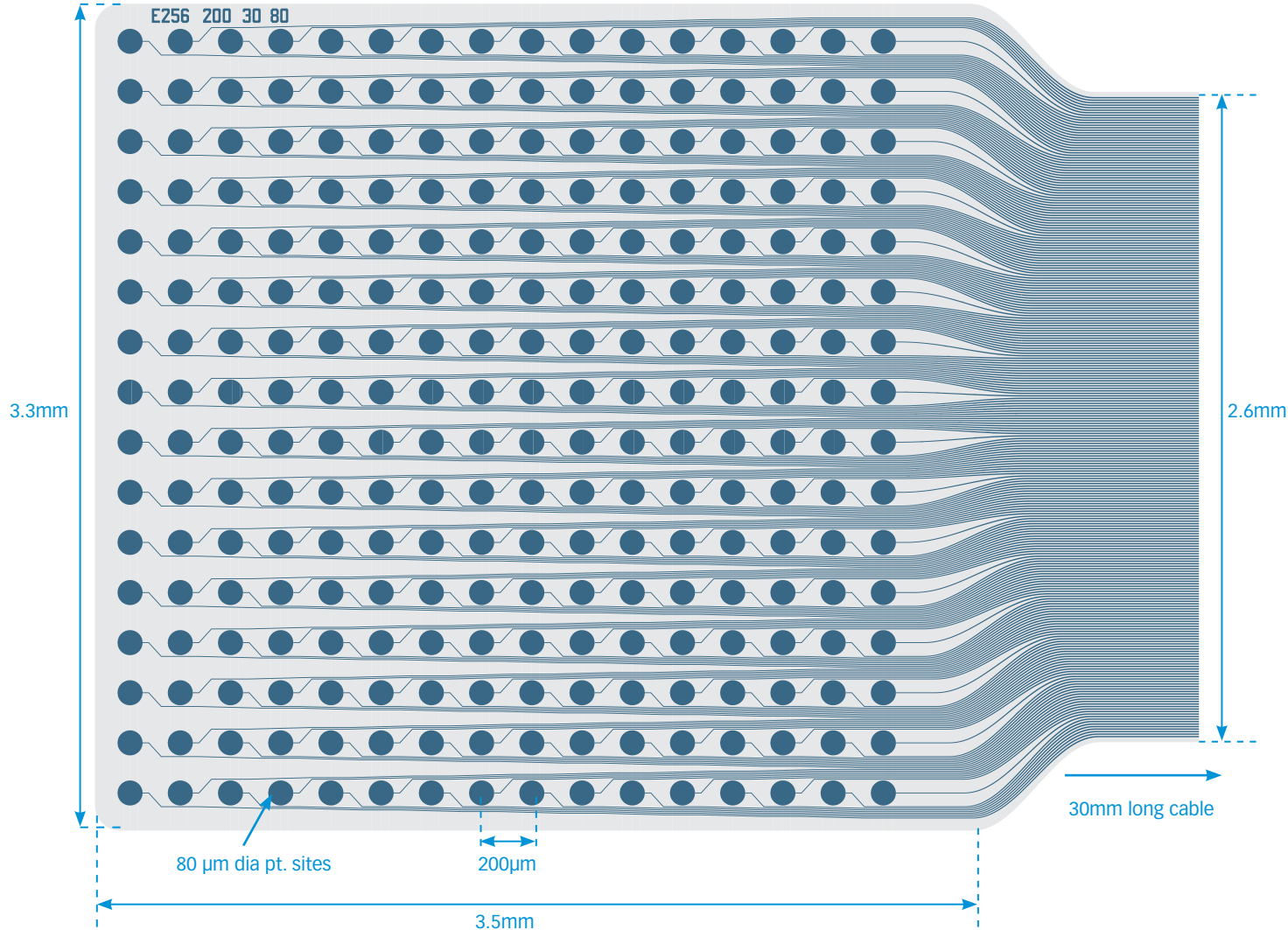

Available packages

CHRONIC
AVIH128
H256
IH256
AVH256
AVIH256

Thickness

15 μm

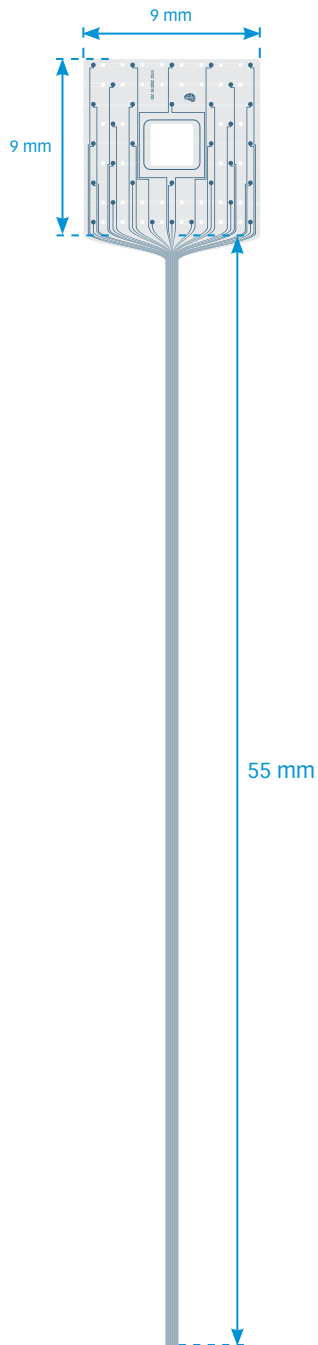

EM32-2000-55-200

ECoG can take the place of one of the four matrix probes.

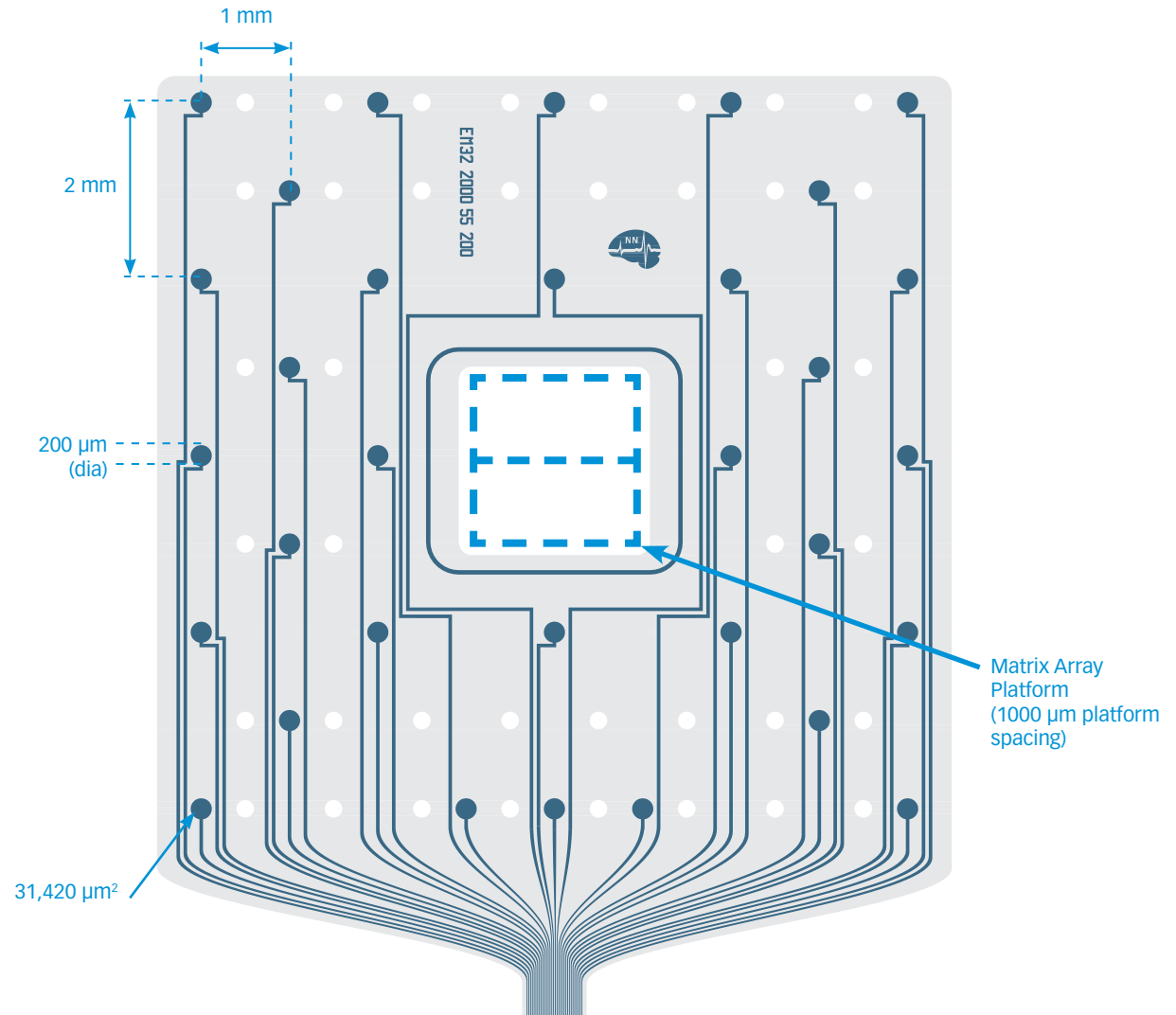

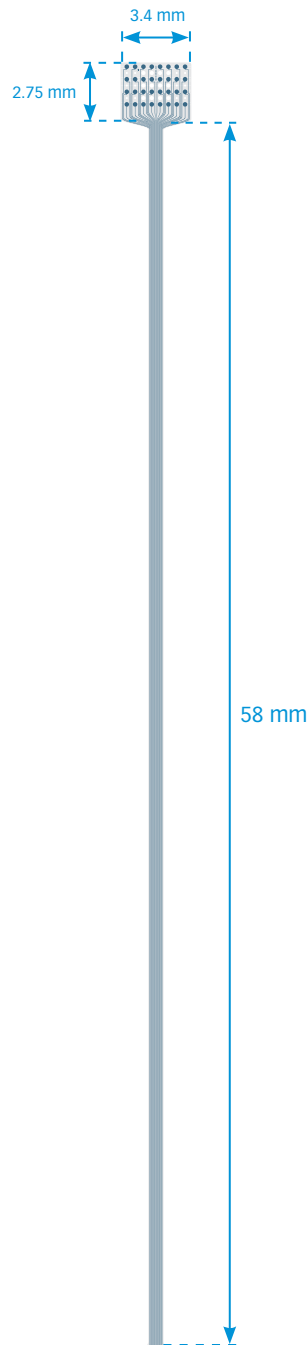

EM32-400-600-58-200

ECoG can take the place of one of the four matrix probes.

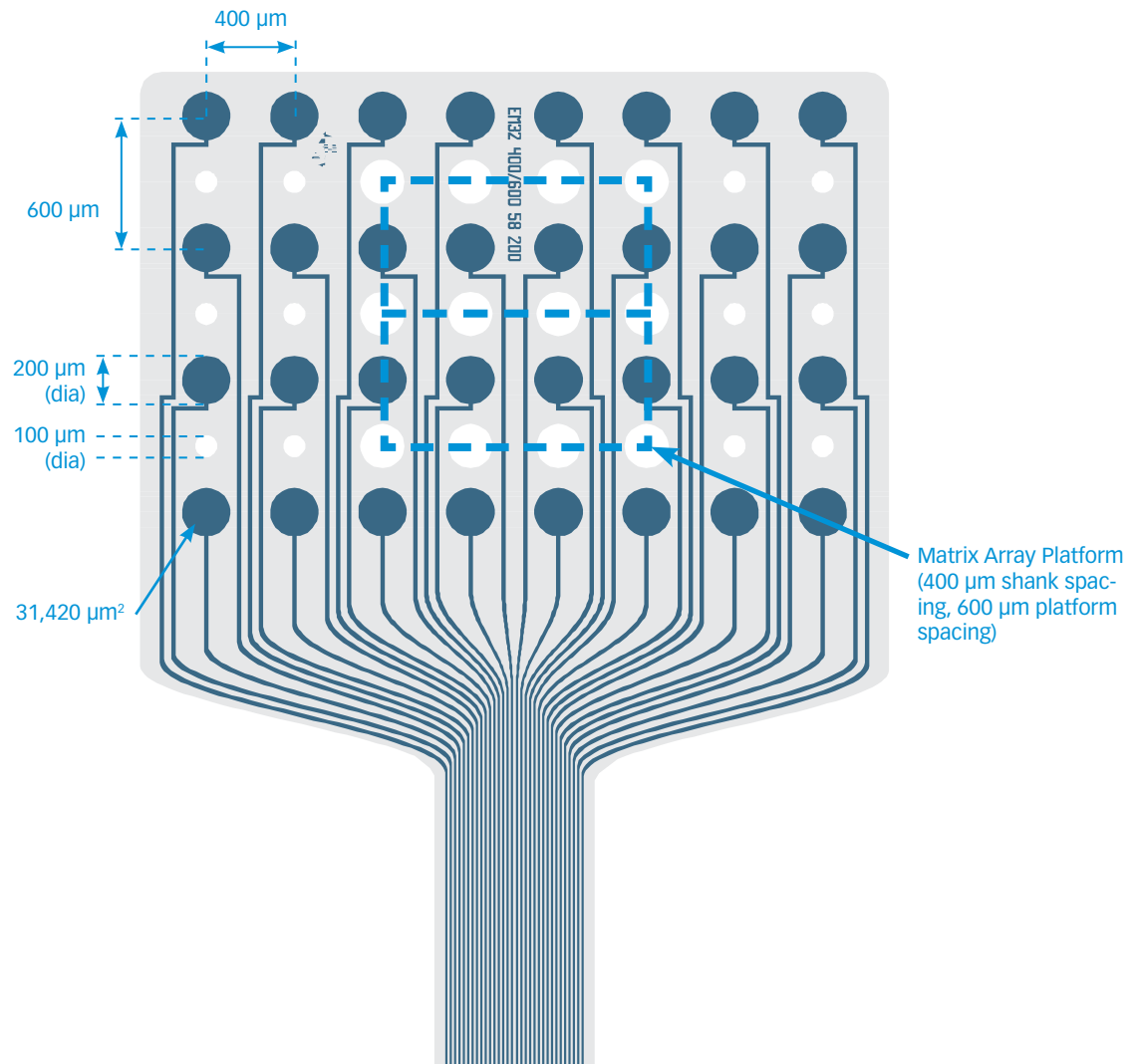

Cardiac Surface Grids

BACK TO
INDEX



ABOVE: EKG recordings with NeuroNexus Cardiac Surface Grid using the SmartBox

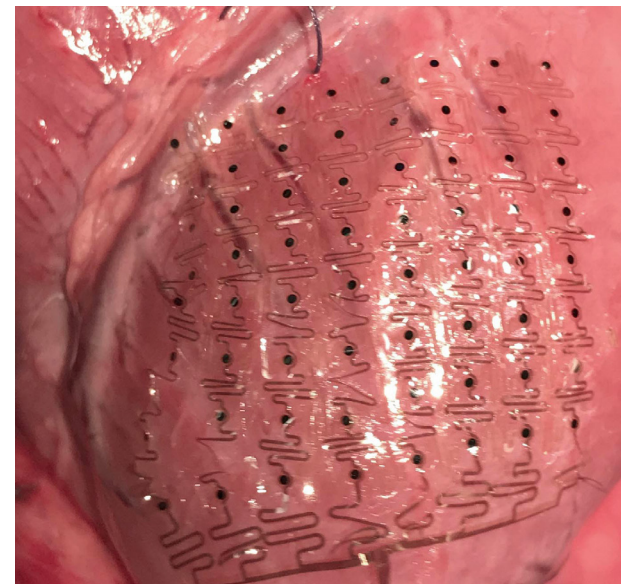

ABOVE: NeuroNexus Cardiac Surface Grid on heart surface

NeuroNexus **Cardiac Surface Grids** are fabricated using our polymer MEMS technology, resulting in an ultra-flexible substrate designed to conform to the cardiac surface. Cardiac Surface Grids can be combined with penetrating probes.

High Recording Resolution – Discover fine detail with our unique high-resolution cardiac grids.

Vast design space – Grids can be customized to your specific needs. Adjust size, channel count, contact density, and more. Special features can be integrated to cope with the particular demands of neurocardiology.

Low noise from tissue movement – Our cardiac grids have been engineered and tested to minimize noise from tissue movement.

SPECIFICATIONS

Substrate Material	Polyimide
Electrode Site Material	Platinum
Array Thickness	15 μ m
Channel Count	16, 32, 64, 128 (varies by design)
Available Packages	H16, HC16, HZ16, X3-H16, H64, H64LP, HZ64, X3-H64, AVH128, AVIH128, X6-H128

CS2x2x4-accord-4000-150-575

TIP DETAIL

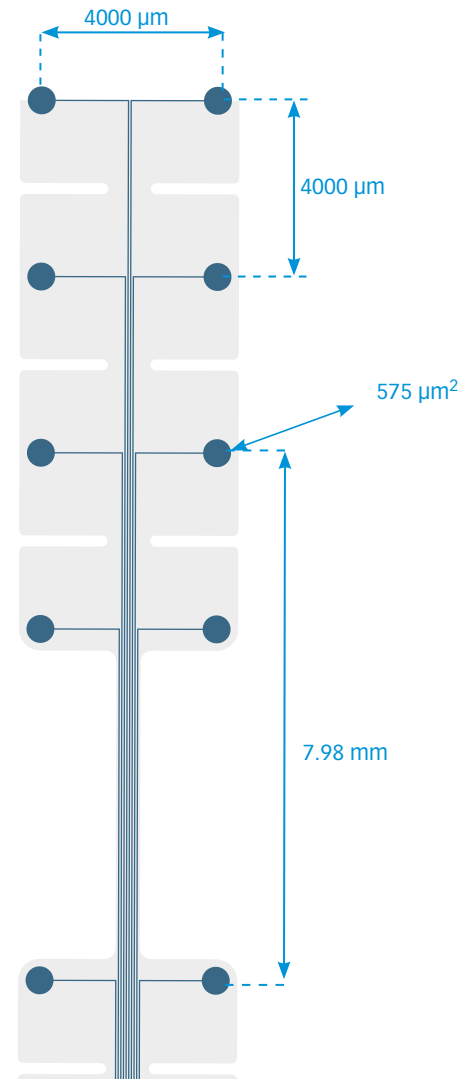
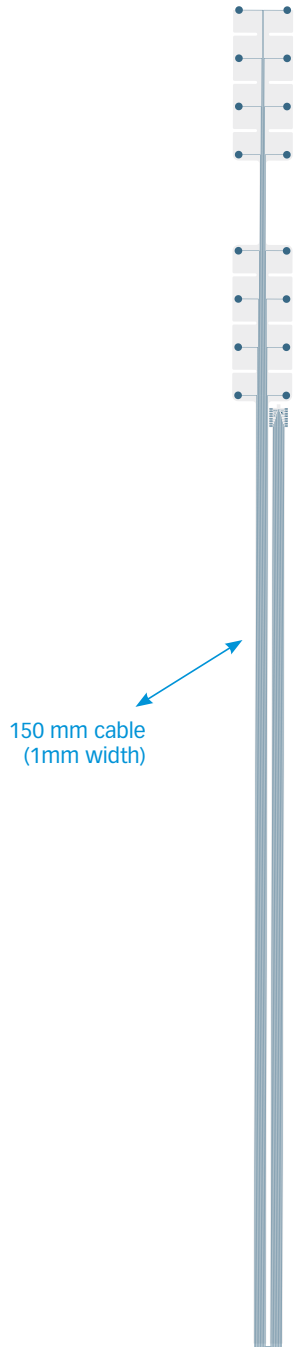

Available packages

CHRONIC

H16
HC16
HZ16
X3-H16

Thickness

15 μm

CS8x8-seg-2000-150-575

CS8x8-seg-4000-150-575

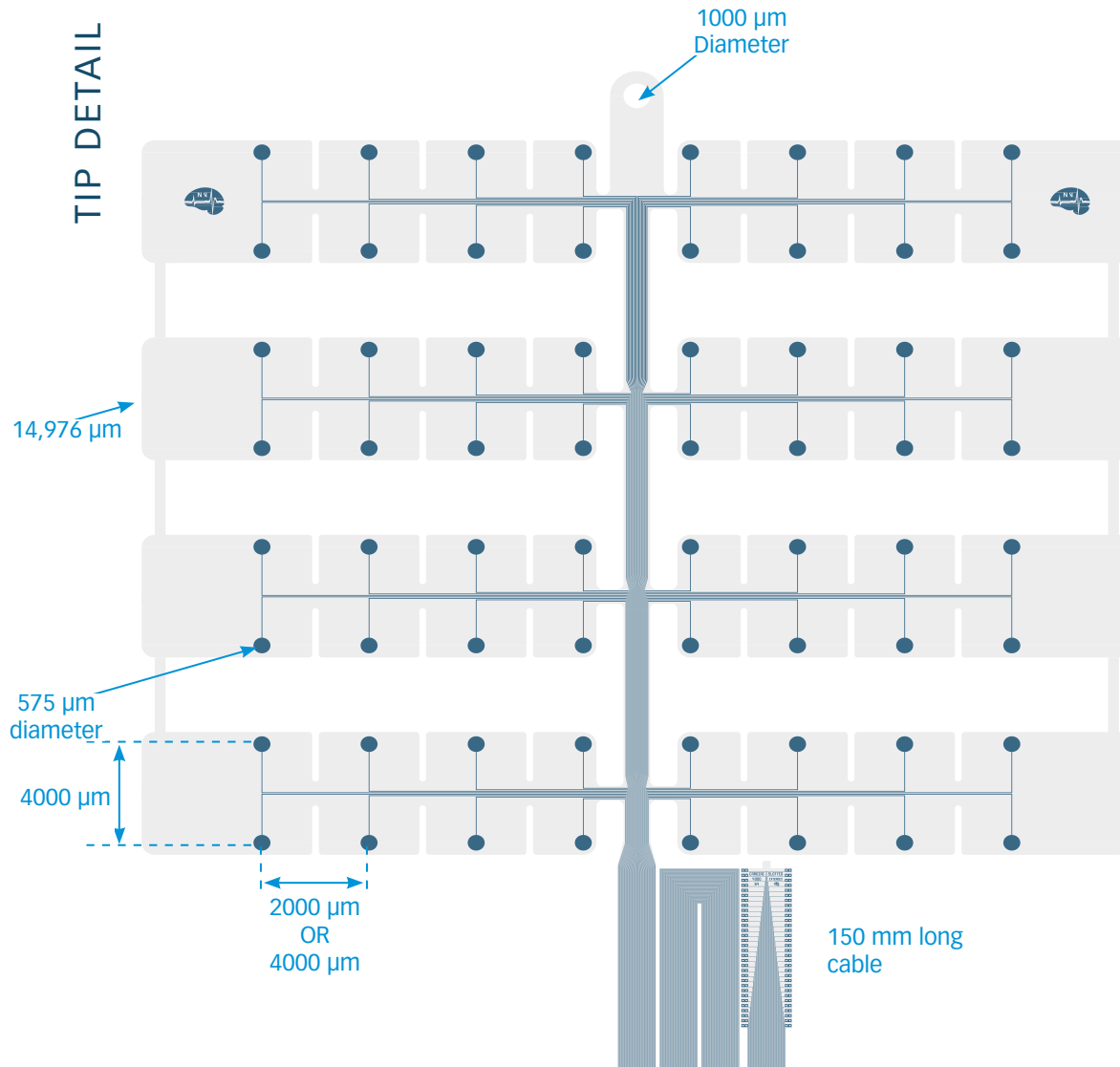

Available packages

CHRONIC

- H64
- H64LP
- HZ64
- X3-H64

Thickness

15 μm

CS8x8-mesoA-4000-150-575

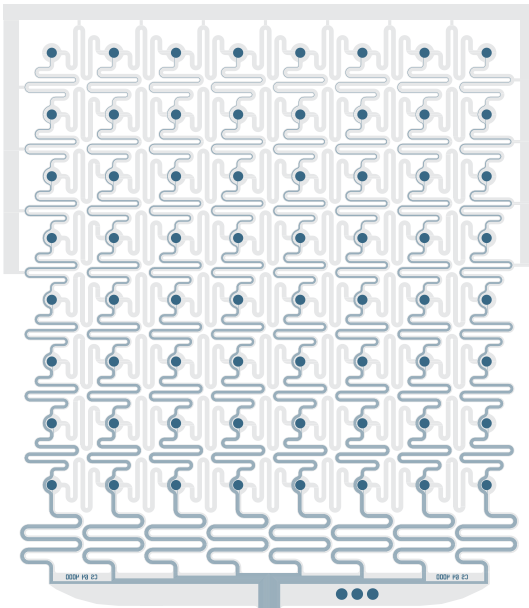

Cable is ~15cm full length
when extended

TIP DETAIL

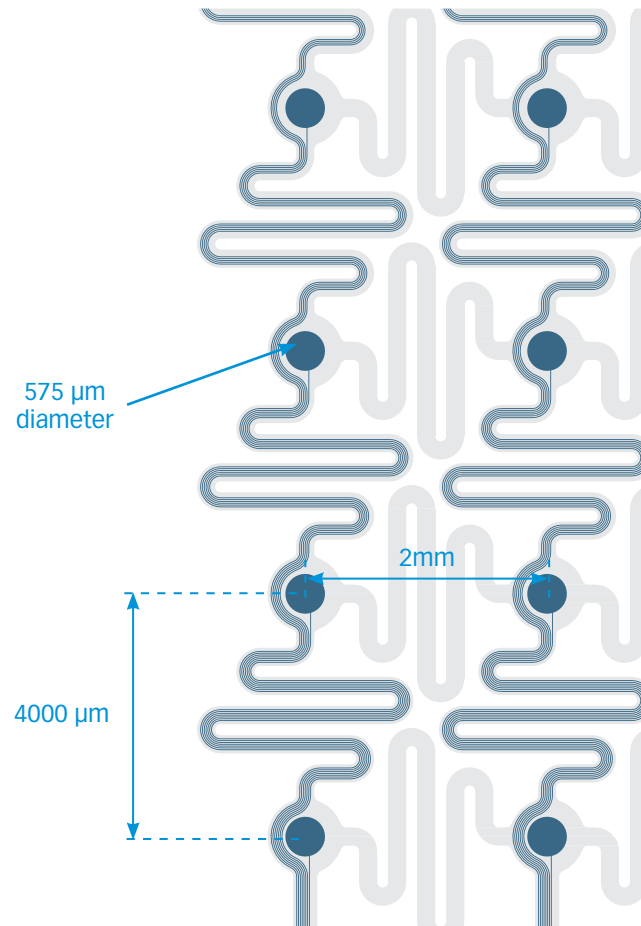

Available
packages

CHRONIC

H64
H64LP
HZ64
X3-H64

Thickness

15 µm

CS8x16-mesoA-2000-150-575

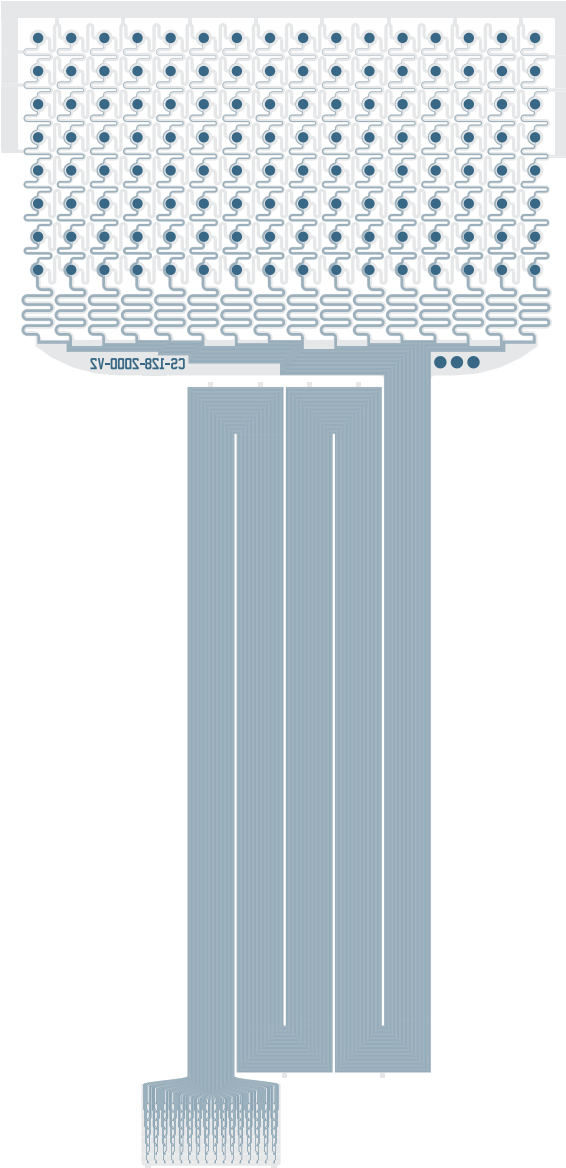

Cable is 15cm full length
when folded

TIP DETAIL

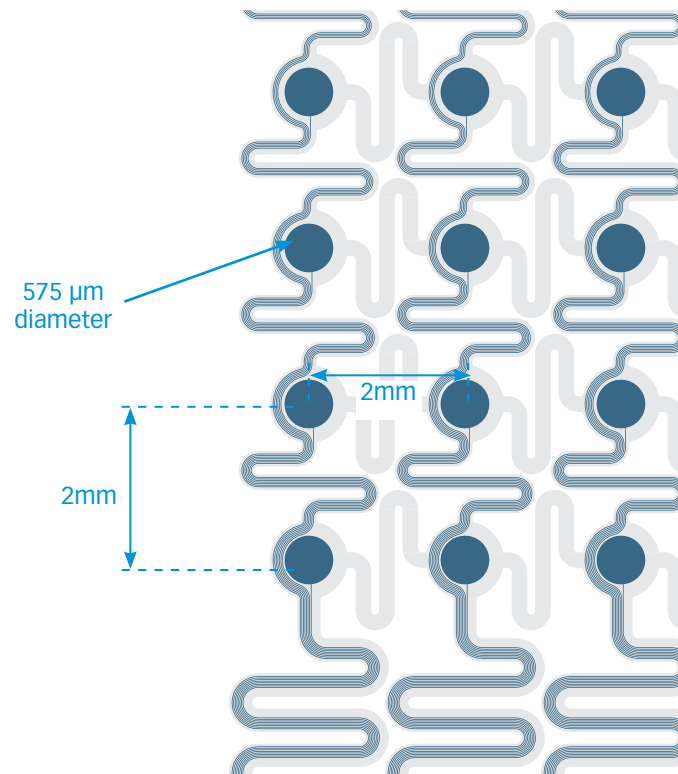

Available packages

CHRONIC
AVH128
AVIH128
X6-H128

Thickness

15 μ m

Peripheral Nerve Cuffs

[BACK TO INDEX](#)

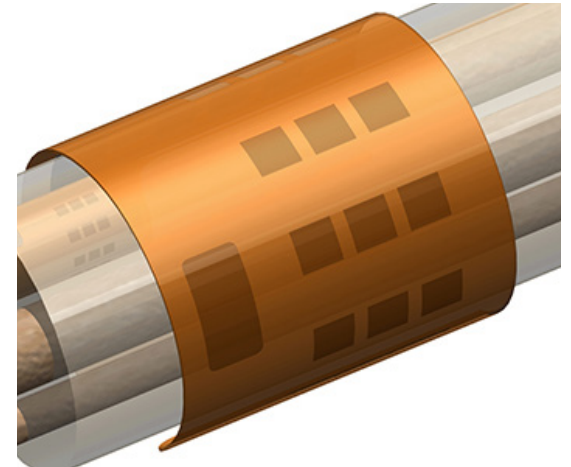
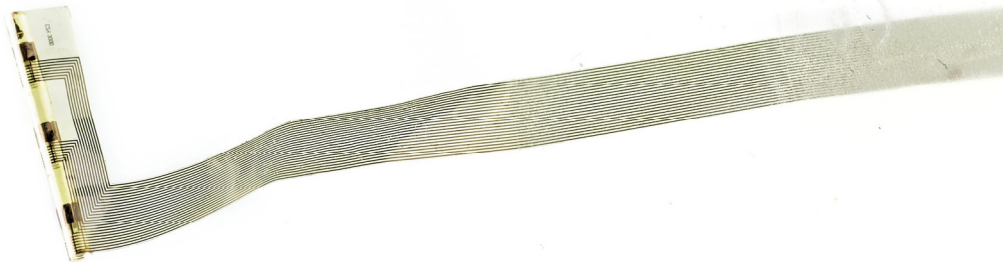

ABOVE: NeuroNexus Nerve Cuffs can be pre-curved to fit any diameter.

NeuroNexus **Nerve Cuffs** enable high-resolution recording and stimulation in peripheral nerve applications. Nerve Cuffs can be custom designed and pre-curved to interface with a variety of nerves.

With a thickness of merely 20 μm , the Nerve Cuff is extremely flexible, allowing it to be wrapped around a nerve. Our versatile MEMS process lets you design recording and stimulation sites in almost any configuration to meet your experimental needs.

Alternatively, a sieve-type microelectrode array can be realized by designing arrays with holes, which can be seeded with neural growth factor to promote axonal growth through the microelectrode sites.

SPECIFICATIONS

Substrate Material	Polyimide
Electrode Site Material	Platinum
Array Thickness	15 μm
Channel Count	3, 24 (varies by design)
Available Packages	H16, H32

C3

Available packages

CHRONIC
H16

Thickness

15 μ m

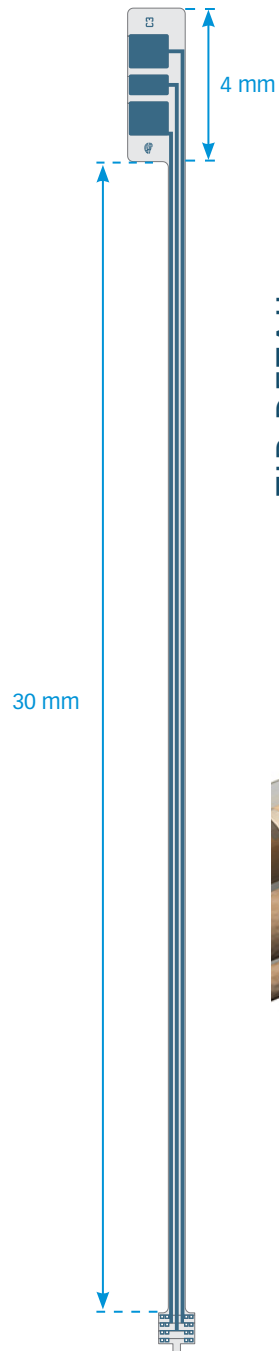

TIP DETAIL

Cuff array can be pre-curved to nerve diameter

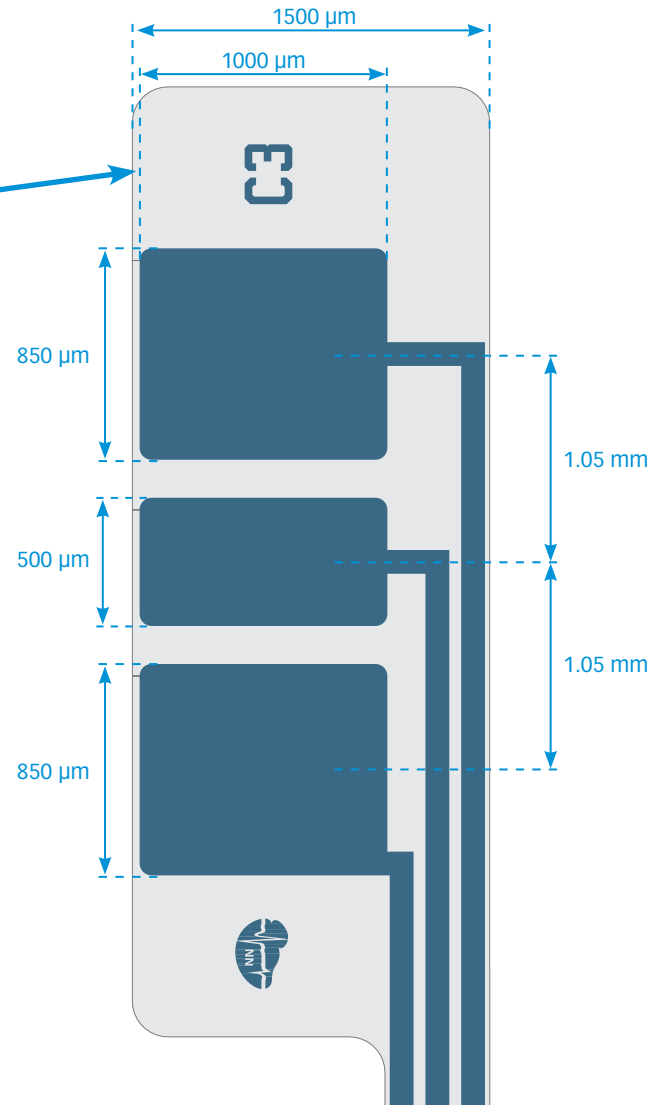
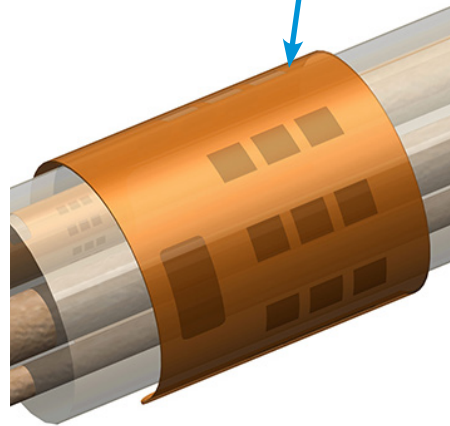

C3 Cuff designed for 350 μ m diameter nerve (customizable)

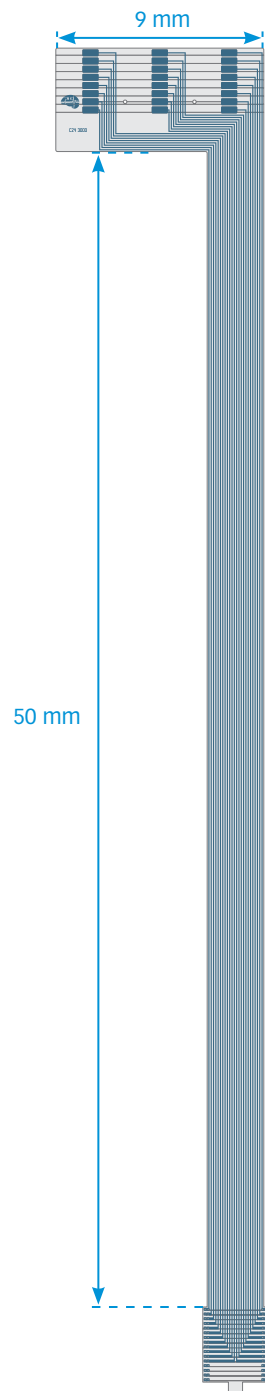

TIP DETAIL

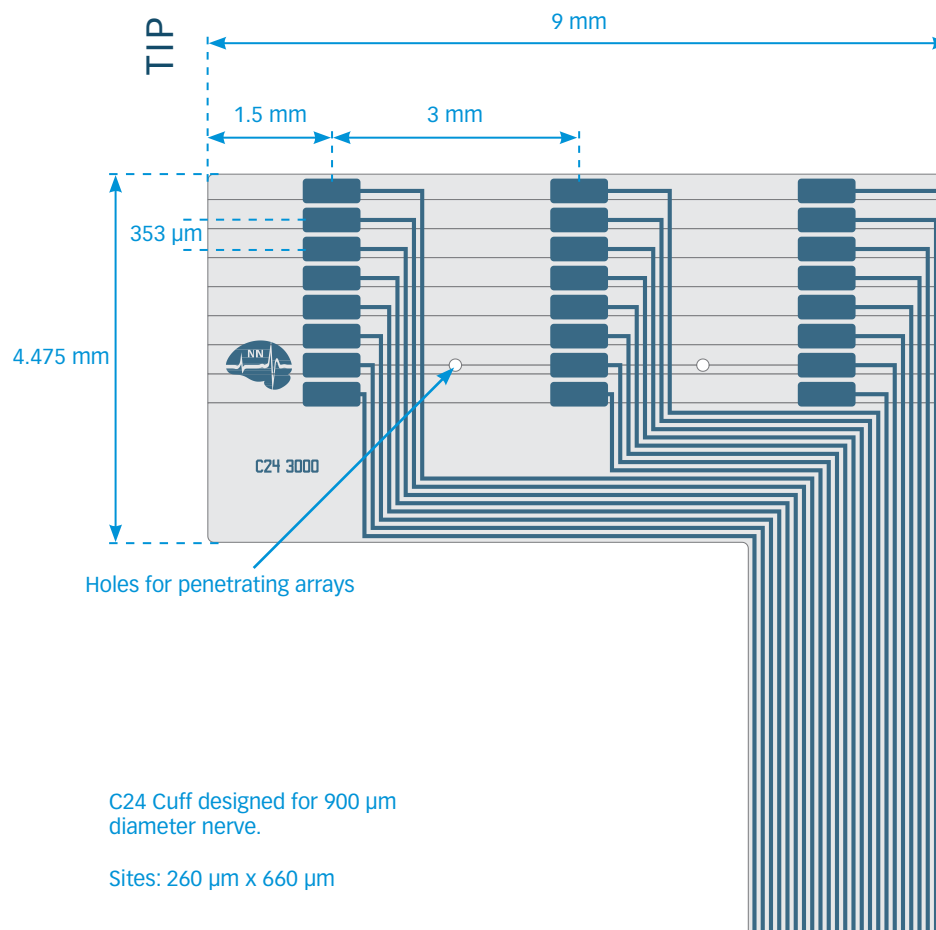

C24

Available packages

CHRONIC
H32

Thickness

15 μm

C12-3000

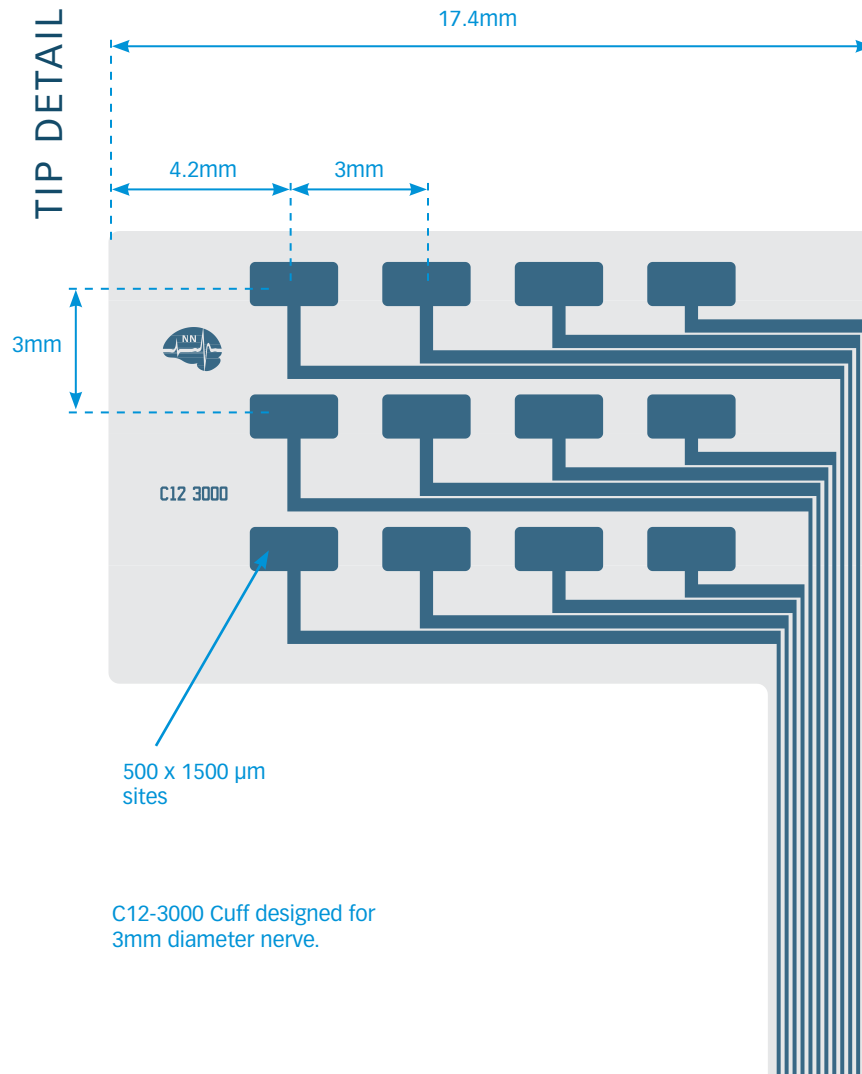
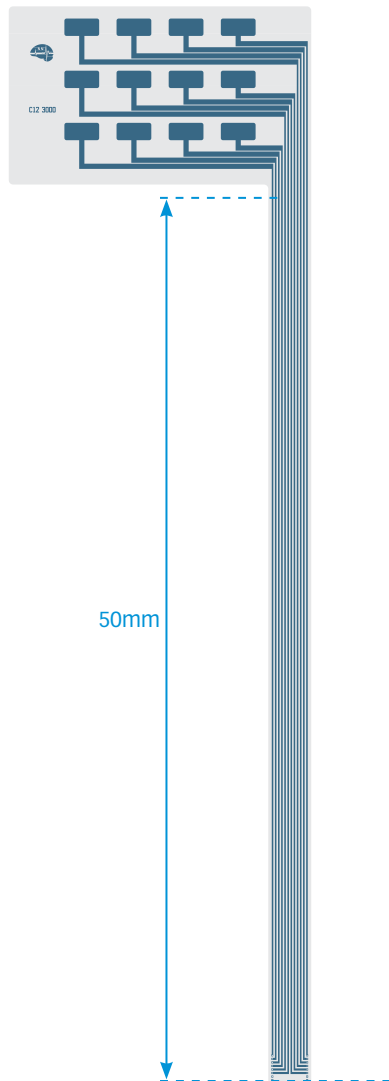

C12-3000 Cuff designed for 3mm diameter nerve.

Available packages

CHRONIC
H32

Thickness

15 μ m

Drug Delivery

COMBINED DRUG DELIVERY AND ELECTROPHYSIOLOGY

BACK TO
INDEX

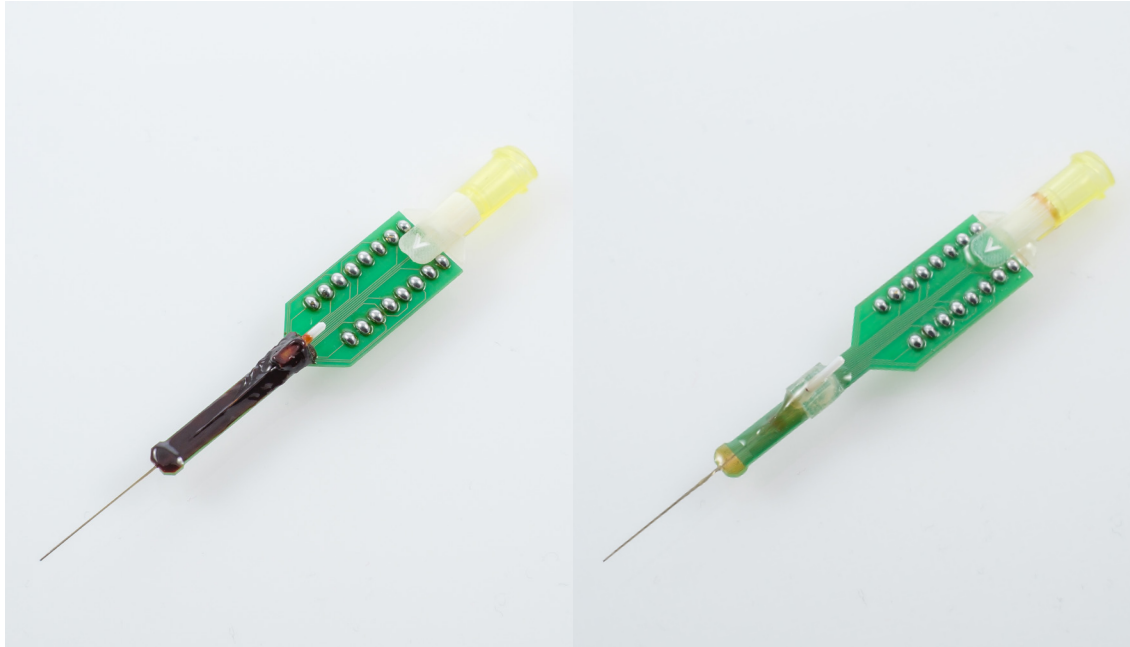

The E16-20mm-100-177 electrode array can be mounted on a fluidic tube to combine drug delivery and electrophysiological recording.

The fluidic tube is mounted on the lower side of the microelectrode array, and the delivery port is at the distal end of the fluidic tube. The fluidic interface is compatible with standard **Luer taper** fittings for interfacing with external injection pumps. Typically, a pressure-based delivery mechanism is used.

Add optical stimulation capabilities, with an optical fiber laminated onto the probe. As with many of our products, the fluidic probe can be customized. Contact us for your customization needs.

SPECIFICATIONS

Electrode Site Material	Platinum
Total Probe Thickness	≈185 μm
Coupling Conduit	Luer taper (polypropylene)
Fluidic Tube	32 gauge / 0.241 mm Stainless steel
Fluidic Port Tip Angle	90° (standard), 45°
Implantable Length	15 - 18 mm
Electrode Coverage	1.5 mm
Channel Count	16
Available Packages	D16, DM16, OD16LP

E16-10mm-25-177

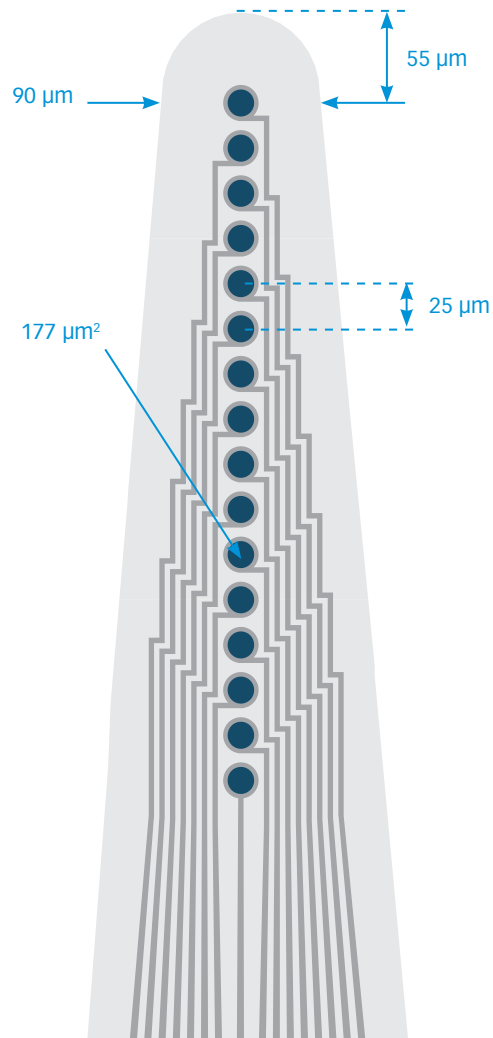
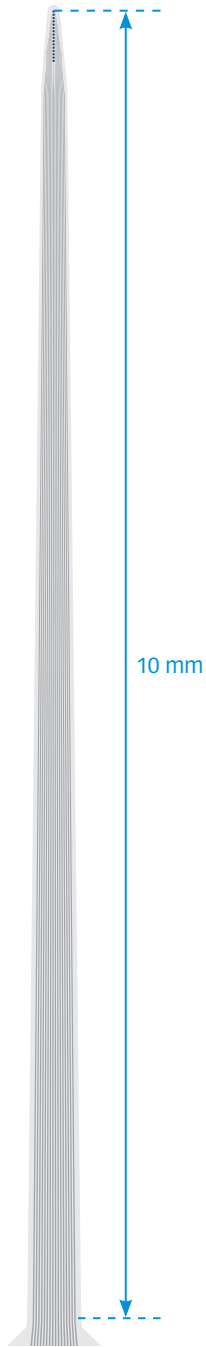

Available packages

ACUTE
D16

CHRONIC
DM16

OPTOGENETICS
OD16

Thickness

15 μm

E16-10mm-50-177

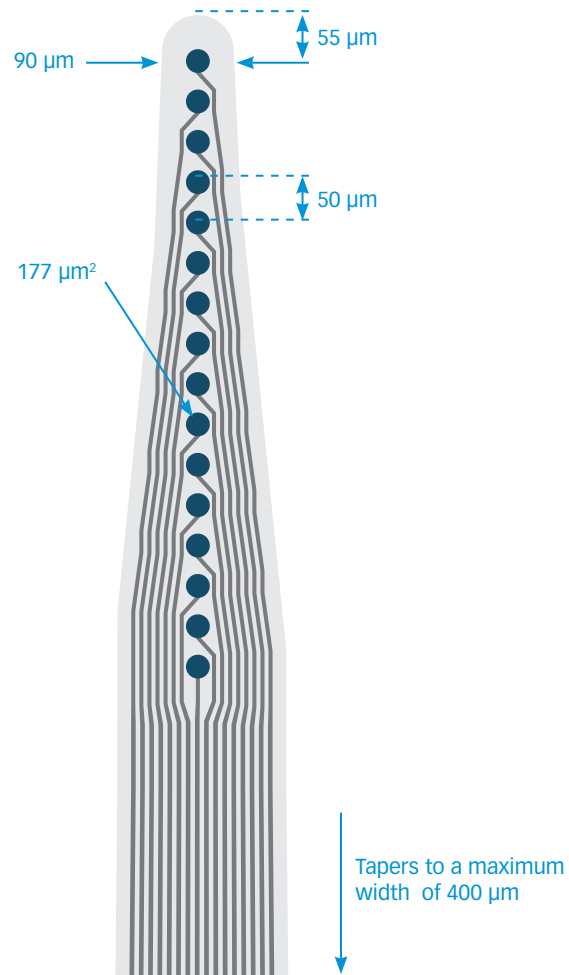
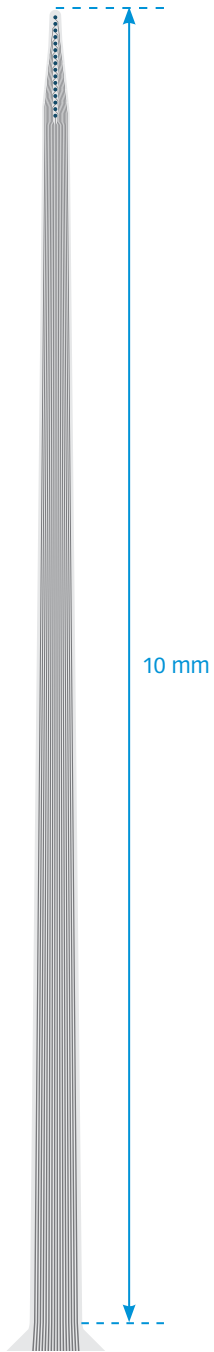

Available packages

ACUTE
D16

CHRONIC
DM16

OPTOGENETICS
OD16

Thickness

15 μm

E16-20mm-100-177

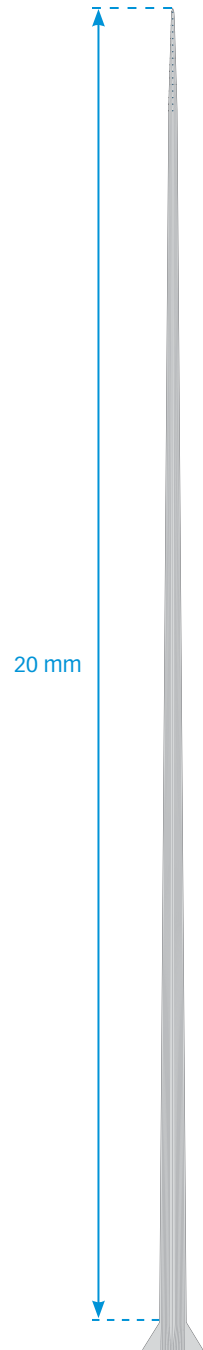

TIP DETAIL

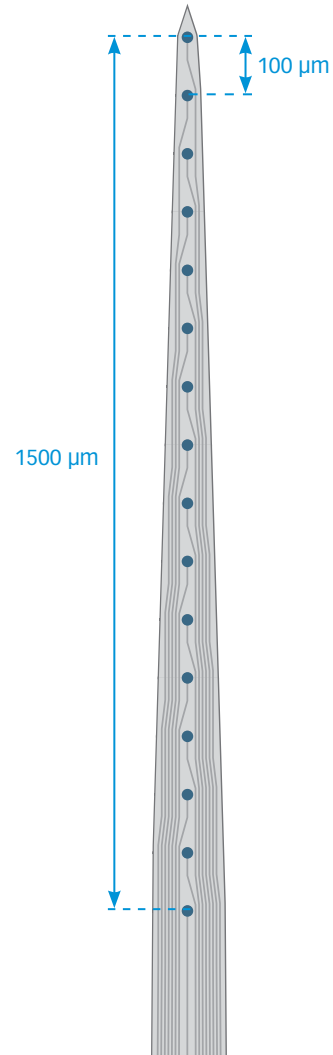

Available packages

ACUTE
D16

CHRONIC
DM16

OPTOGENETICS
OD16

Thickness

15 μm